



2023
SEPTEMBER 1 - 4
LABOR DAY WEEKEND
FORT TUTHILL COUNTY PARK IN FLAGSTAFF, AZ

FAIR BOOK



Your source for entering and showing at the Coconino County Fair.
It's FREE or low-cost to enter & PRIZES are available in every department!

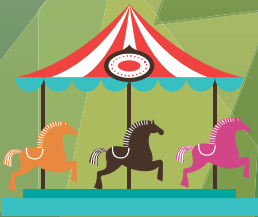

COCONINOCOUNTYFAIR.COM

(928) 679 8000



Scan for a PDF
of the Fair Book



FRIENDS OF COCONINO COUNTY PARKS



WE ADVOCATE FOR AND RAISE FUNDS TO
SUPPORT COCONINO COUNTY PARK
INITIATIVES AND IMPROVEMENTS LIKE THESE.



Shade at Sawmill



Trail Signage



Flagstaff Snowplay

TO LEARN MORE, VISIT
WWW.FRIENDSOFCOCOPARKS.ORG





September 1 – 4, 2023 • Labor Day Weekend Friday • Saturday • Sunday • Monday

Since its establishment in 1949, the Coconino County Fair continues to promote community involvement and interest in agriculture, horticulture, livestock, household arts, and diverse traditions, as well as many other areas.

This is accomplished by providing an educational and entertaining experience in a family-friendly environment that encourages the public to showcase their accomplishments.

Fair Hours

Friday, September 1	10 a.m. to 10 p.m.
Saturday, September 2	10 a.m. to 10 p.m.
Sunday, September 3	10 a.m. to 10 p.m.
Monday, September 4	10 a.m. to 4 p.m.

Carnival Hours

Friday, September 1	10 a.m. to 11 p.m.
Saturday, September 2	10 a.m. to 11 p.m.
Sunday, September 3	10 a.m. to 11 p.m.
Monday, September 4	10 a.m. to 5 p.m.

Some exhibit buildings will close at 9 p.m. Friday - Sunday.

Fair Admission Prices

Please see CoconinoCountyFair.com for admission prices.

For More Information

Coconino County Parks and Recreation
2446 Fort Tuthill Loop
Flagstaff, Arizona 86005-8701
Phone: 928-679-8000
CoconinoCountyFair.com
Facebook.com/CoconinoCountyFair
Instagram.com/CoconinoCountyFair

General Inquiries:

fair@coconino.az.gov

Entry Questions and Support:

entries@coconino.az.gov

Produced by:



Table of Contents

Letter from the Fair Manager	3
In-County Outreach Program	4
2023 Coconino County Officials	5
How to enter an exhibit into the Fair	6
General Fair Rules.....	7
Important Dates & Deadlines By Department.....	8
Livestock Show Schedule.....	9
Entry Form A – NON-LIVESTOCK.....	10
Entry Form B – OPEN LIVESTOCK.....	11
Entry Form C – SCHOOLS	12
Coconino County Parks and Recreation	13
General Livestock Rules	14
Junior Livestock Exhibitor Grievance Procedures	17
Round Robin Showmanship Procedures	18
Show Ring Code of Ethics.....	19
Coco the Cow Coloring Sheet	21
Northern Arizona Junior Livestock Association Sponsors.....	22
2022 Livestock Auction Buyers List.....	23
2022 Livestock Grand Champions.....	24
2022 Livestock Reserve Champions	25
Northern Arizona Junior Livestock Association, Inc. Auction Rules.....	26
Agriculture & Horticulture	29
Fine Arts	37
Floriculture.....	41
Gems & Minerals	50
Hobbies & Collectibles	51
Home Economics	53
Junior Beef	64
Junior Camelid.....	66
Junior Club Work.....	67
Junior Goat.....	72
Junior Horse Show & Gymkhana.....	74
Junior Poultry.....	76
Junior Rabbits & Cavies	81
Junior Sheep.....	85
Junior Swine.....	87
Hog Bowl Sponsors	90
Open Horse Show	91
Open Poultry	92
Open Rabbits & Cavies	93
Open Youth	98
Schools.....	102
Schools Day.....	103

Letter from the Fair Manager

Greetings Fairgoers!

Coconino County Parks & Recreation is in planning mode for the upcoming Coconino County Fair. We have several initiatives underway, including vendor recruitment, booking entertainment, finishing up this Fair Book, and working on adjusting the fees and flow of the Fair. It's a busy time at Fort Tuthill County Park, but with that comes a lot of excitement as we get closer and closer to Labor Day Weekend.



The theme of this year's letter (yes, they usually have a theme) is tradition. The Coconino County Fair turns 74 this year! Through all that time, tens of thousands have made their own County Fair traditions. Many people have been participating in the event in one form or another through multiple generations. There are many ways in which to participate at the Coconino County Fair, and I will highlight them below.

For many, participating means exhibiting through one of our Junior Exhibit Departments. When we use the term 'junior', we mean any exhibitor who participates in the Fair as part of the local 4-H or FFA program. Most of our Junior Exhibitors typically come from a long line of families who have exhibited over Labor Day Weekend. When I speak to the families of Junior Exhibitors, I often hear about the generations that exhibited before and the hope that it continues after. These exhibitors often participate in the Coconino County Fair on an annual basis from ages 8 to 18, which means their families are typically participating in a big way during that time as well.

The Fair encourages participation from another class of exhibitors, those from the Community. We get entries from the Community in many different Departments, including Fine Arts, Home Economics, Open Livestock, Floriculture, Agriculture & Horticulture, and many others. We accept entries from people of all ages and abilities in our buildings. There is no cost to enter, except a nominal fee for Open Livestock; and participants are eligible to win ribbons, gift certificates, and/or cash prizes! Cash prizes are available thanks to our sponsor, the Friends of Coconino County Parks (<https://friendsofcocoparks.org>).

Another subset of people that participate annually in the Coconino County Fair are the people working the event. This is a large group of people that includes the full-time staff, temporary event staff, entertainers, sponsors, volunteers, vendors, partners, and contracted personnel. We see a lot of repeat visitors each year in this group as well. We try to keep entertainment and vendors fresh, but there are fan favorites in both of those areas, so some return on an annual or semi-annual basis. For example, the Flagstaff Dancin' Grannies and Flagstaff Community Band have been performing at the Coconino Fair for a very long time and are local favorites.

The last group of participants are the attendees. This group makes up the vast majority of people who interact with the Fair. They did not enter any exhibits, nor are they working or volunteering. They want to get into the Fairgrounds to do some variation of getting fair food and drinks, listening to music, walking through the buildings to see the exhibits and vendors, and riding on rides. Many attendees have also been coming to the Fair for many generations.

Each group mentioned above plays an important role in the Coconino County Fair. The displaying and judging of entries are pivotal parts of the County Fair experience. Without Junior or Community Exhibitors, our event wouldn't be a County Fair. The efforts from exhibitors also provide the Fair with demonstrations and displays that are enjoyed by all who attend the Fair. We obviously couldn't put on the Coconino County Fair without the hundreds of staff, volunteers, vendors, entertainers, sponsors, partners, and all the other people who work tirelessly before, during, and after Labor Day Weekend. The last group, attendees, help make many of our goals possible because this group generates the most revenue, which is what keeps the Fair operational and growing each year. No group is more important or impactful than the others, and each work together in order to provide an excellent County Fair experience.

We'll see you at the Fair!

Sincerely,
Ricky Conway
Fair Manager

In-County Outreach Program

Attention:
Fredonia, Page, Grand Canyon, and Williams

Showcase your work at the Fair!

Make sure your best pieces of art, crafts or hobbies get into the Fair. The in-county outreach program allows you the opportunity to have your non-livestock, non-perishable entries for the Coconino County Fair to be picked up and returned by the Parks & Recreation Department at a convenient location. **With a minimum of 10 exhibitors or entries in each area**, Fredonia, Page, Grand Canyon, and Williams can be part of the program.

Round up your friends and family, have them enter an exhibit and the gas is on us!

Drop Off Locations:

Fredonia Public Library
118 North Main Street
Fredonia, AZ 86022
(928) 643-7137
Friday, August 18
11:00 a.m. – 1:00 p.m.

Grand Canyon Community Recreation Center
2 Mohave St.
Grand Canyon National Park, AZ 86023
928-635-3389
Friday, August 18
11:00 a.m. - 1:00 p.m.

Williams Public Library
113 South 1st Street
Williams, AZ 86046
(928) 635-2263
Saturday, August 19
10:00 a.m. – 12:00 p.m.

Page Public Library
479 S. Lake Powell Blvd.
Page, AZ 86040
(928) 645-4270
Friday, August 18
11:00 a.m. – 1:00 p.m.

To take advantage of this opportunity, please initial at the bottom of the appropriate entry form.

A minimum of 10 entries from each outreach site is required. Please call the Parks & Recreation Department at (928) 679-8000 prior to the scheduled pick-up date to ensure that a pick-up is scheduled.

All entries must be submitted by the stated deadline(s) using the appropriate Fair entry form(s). Exhibitors can enter online at CoconinoCountyFair.com/entries.

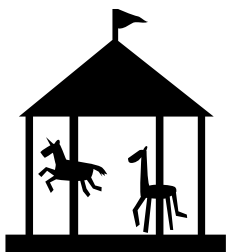

2023 Coconino County Officials

Coconino County Board of Supervisors

Patrice Horstman, Chair – District 1
Jeronimo Vasquez, Vice Chair – District 2
Matt Ryan, Supervisor – District 3
Judy Begay, Supervisor – District 4
Lena Fowler, Supervisor – District 5

Parks and Recreation Commission

Howard Brown, Chair – District 1
Daniel Hiel, – District 1
Vacant – District 2
Vacant – District 2
Brian Blue – District 3
Jean Marie Rieck, Vice Chair – District 3
Mary Hendricks – District 4
Vacant – District 4
Steve Mongrain – District 5
Vacant - District 5

Coconino County Parks & Recreation

General Inquiries, Vendors
Entries

(928) 679-8000, fair@coconino.az.gov

(928) 679-8030 (voicemails will be returned), entries@coconino.az.gov

Fair Superintendents

Agriculture & Horticulture
Fine Arts
Floriculture
Gems & Minerals
Hobbies & Collectibles
Home Economics
Junior Beef 4-H
Junior Camelid 4-H
Junior Club Work 4-H
Junior Goat 4-H
Junior & Open Horse Show 4-H
Junior Horse Gymkhana 4-H
Junior Poultry 4-H
Junior Rabbits & Cavies 4-H
Junior Sheep 4-H
Junior Swine 4-H
Livestock Coordinator
Open Poultry
Open Rabbits & Cavies
Open Youth
Schools

Nick Lipinski & Galen Guerrette
Nancy Reniker-Neve & Dorene Washington
Carol Burris
Janet Findley
Christina Rankin & Andrea Guerrette
Christina Rankin & Andrea Guerrette
Troy Mortensen
Eric Souders

Lori Willman
Lori Penrod
Lori Penrod
Anthony Campbell
Stacie Muller-Stotts
Bailee Cameron
Sandy Engelke
Eric Treece
Connie Lipinski
Doreen Holtje
Beverly Standing & Becca Dickerson
Lynda Locke

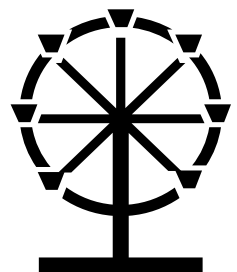

How to enter an exhibit into the Fair

Go to CoconinoCountyFair.com or use the forms in this book.

1. Find the department/s or category that represents your area of interest – Agriculture & Horticulture, Home Economics, Open Poultry, Fine Arts, etc.
2. Find the entry form for your area of interest:
 - Entry Form A – is for non-livestock, non-4-H entries such as Agriculture & Horticulture, Gems & Minerals, Home Economics, etc.
 - Entry Form B – is for anyone entering an animal in an Open animal category and not in 4-H.
 - Entry Form C – is for schools entering in the Schools Building.
 - Entry Form D – is for the livestock judging contest
 - Youth involved in 4-H projects must submit entries online through CoconinoCountyFair.com.
3. Complete the Entry Form.
 - Department Code – The two letter code for each Department. These are found on the first page of each Department's section in the Fair Book.
 - Division Code – Is a one or two letter code found on the first page of some Department's section in the Fair Book. The code will denote one's age group or level of expertise.
 - Class Number & Description – Are the multi-digit number and description for the specific item you want to enter. For example, the Class number and Description for a Card Collection in the Hobbies & Collectibles Department looks like this:
CARD COLLECTIONS

Dept	Div	Class	Description
HC	A	110	Card Collections
4. Fill out the form online, email, or mail your entry form as indicated on the entry form. A separate entry form is required for each department you entered into. Note: One entry per Class number unless otherwise stated in the department guidelines.
5. Photographs of submitted entries may be used for Coconino County Fair promotional purposes and may not credit the entrant.
6. Still have questions? You can contact the Superintendent whose contact information is on the first page of each Department's section in the Fair Book or call the Entries Hotline at (928) 679-8030 or email entries@coconino.az.gov.

Helpful Definitions

1. Class Number – A number assigned to individual entries or competitions.
2. Department Code – The two-letter code identifying each department for example, AH is Agriculture & Horticulture.
3. Division Code – A group of exhibits sharing similar characteristics such as age, skill level, division or breed.
4. Entry or Exhibit – An eligible animal or exhibit (object or collection of objects) which is entered to be judged.
5. Exhibitor – The individual or entity submitting an entry and responsible for animals and articles entered. If not the owner of the articles or animals entered, the exhibitor is acting as agent for such owner. In the case of a minor, the exhibitor is defined as participant and parent and/or legal guardian.
6. Judging – American System: The judging process to rank exhibits against one another and award one first placing, one second placing, etc. Danish System: The judging process to compare each exhibit on its own merit against the scorecard, where applicable, or recognized standard and award as many first placing, second placing, etc. as merited.
7. Junior - Junior departments are only open to exhibitors enrolled in a Coconino County 4-H/FFA program.
8. Large Livestock – Includes cattle, sheep, swine, goats, and camelids.
9. Small Livestock – Includes poultry, pigeons, rabbits, and cavyes.

Enter your exhibits online!

Save time and hassle by filling out entry forms and paperwork online, while making sure your entry is correct and complete. Visit CoconinoCountyFair.com and click on “**Entries and Exhibits**” for a link to an easy, online system to enter your exhibits. Coconino County Fair uses ShoWorks, the most popular exhibitor and entries management software used by many state and county fairs.

Enter online or get entry forms at CoconinoCountyFair.com
Email your entry questions to entries@coconino.az.gov



General Fair Rules

In addition to these General Fair Rules, all other rules listed in the Fair Book apply. Violation of any rule as listed may result in disqualification from the Fair, removal of exhibitor and/or exhibits from the fairgrounds, and/or forfeiture of awards. Please read all rules carefully.

1. All rules are subject to interpretation by Coconino County Parks and Recreation (CCPR). CCPR reserves the right to add or amend these rules as deemed necessary.
2. All departments are open to Coconino County residents ONLY unless stated otherwise in the individual department rules.
3. Commercial organizations, non-profit organizations, and any others exhibiting articles not-for-competition must make arrangements with the Fair Manager. The Fair Manager will, in all cases, be the final authority in matters pertaining to commercial and non-competitive exhibits.
4. CCPR will take every precaution to ensure proper care and protection of exhibits while at the Fair, yet will accept no responsibility for the loss or damage to any exhibit.
5. The only livestock and domestic animals permitted on fairgrounds during the Fair will be as follows:
 - service animals as defined by the ADA
 - registered Fair exhibit animals
 - animals contracted as Fair entertainment
 - animals used for exhibition/demonstration
 - animals approved through CCPR
6. Exhibitors' vehicles will not be allowed on the fairgrounds beginning Wednesday before the Fair through the end of the Fair, except with the approval of Fair management. Non-motorized carts are allowed.
7. All Junior exhibitors must complete forms online.
8. All entries must be completed by the deadline stated on each department's page and submitted online, mailed, or brought to CCPR, located at Exit 337 off I-17. Mail: 2446 Fort Tuthill Loop, Flagstaff, AZ 86005. No late entries will be accepted. Use entry forms located in the Fair Book (or duplicated copies) or online at www.CoconinoCountyFair.com. Call (928) 679-8030 or email entries@coconino.az.gov for entry related questions.
9. Ribbons and Awards: All departments list whether ribbon, trophy or special awards are available. However, there may be additional awards such as sponsored gift certificates.
10. Exhibitors are responsible for transportation of exhibits to and from the Fair, or to and from County Outreach pickup locations.
11. No exhibit may be entered in multiple classes unless individual department rules state otherwise.
12. CCPR has the authority to disqualify any entrant in case of violation of general or special rules or for misconduct while on the fairgrounds. The decision of the Fair Manager or CCPR Director will be final.
13. Superintendents and/or CCPR reserve the right to refuse entries which are substandard, offensive, or hazardous to the public. CCPR will make the final decision when necessary.
14. Photographs of submitted entries may be used for Coconino County Fair promotional purposes and may not credit the entrant.
15. Five or more entries per exhibitor in one department entitle the exhibitor to 1 one-day free admission to the Fair, to be picked up from the superintendent at receiving.
16. Entry Receiving Locations: Exhibitors must take entries directly to the appropriate Fair building as noted in Fair Book. Parking is available in the main lot north of fairgrounds entrance. For large and/or heavy department entries, vehicles may enter the fairgrounds via the alley west of the Livestock Show Ring or gate south of the Commercial Building. Please be cautious of workers, equipment and vehicles on the fairgrounds. Contact the department Superintendent if you have any questions regarding access to the building on entry day.
17. Coconino County is an equal opportunity provider of event activities and vendor spaces where sundry articles, items, products, documents, materials, parts, assemblies, and plants, animals, minerals and like kinds [altogether called "Product"] are possessed on site and/or presented to the public for display, use, exchange, and/or sale. By signing a license or receiving a permit or other permission from Coconino County to be present at and to use the Coconino County Fairgrounds for the display, exchange or sale of any Product, the Licensee, Exhibitor, and/or possessor of such Product warrants and assures Coconino County that the Product is lawfully possessed, is not counterfeit or contraband material, and the possession of such Product by the Licensee/Exhibitor is not violative of any federal, state or local law, statute or ordinance. Furthermore, the Licensee/ Exhibitor warrants and assures Coconino County that the Licensee/ Exhibitor shall not engage in the possession, display, sale or exchange of Product that Licensee/ Exhibitor knows or has reason to know is counterfeit, contraband, illegal or unlawful. Violation of this provision may expose the offender to prosecution by the appropriate local, state or federal authority. Licensees/ Exhibitors shall cooperate with law enforcement in the investigation and prosecution of offenders.
18. Entry fees must be paid prior to CCPR receiving entry(s).

Important Dates & Deadlines By Department

Department	Entry Forms Due	Receiving Date	Receiving Time
Agriculture & Horticulture	Fri., Aug. 18	Wed., Aug. 30	10 a.m. - 7 p.m.
Fine Arts	Sat., Aug. 5	Fri. Aug. 18	6 p.m. - 8 p.m.
		Sat. Aug. 19	1 p.m. - 6 p.m.
Floriculture	Fri., Aug. 18	Thurs., Aug. 31	2 p.m. - 6 p.m.
Gems & Minerals*	Fri., Aug. 18	Sun., Aug. 27	1 p.m. - 4 p.m.
		Thurs., Aug. 31 (outside of Flagstaff)	10 a.m. - 12 p.m.
Hobbies & Collectibles	Fri., Aug. 18	Sun., Aug. 27	12 p.m. - 4 p.m.
Home Economics	Fri., Aug. 18	Tues., Aug. 29	3 p.m. - 7 p.m.
Home Economics - Quilts Only	Fri., Aug. 18	Sat., Aug. 26	9 a.m. - 12 p.m.
Junior Beef	Fri., Jul. 7	Thurs., Aug. 31	9 a.m. - 4 p.m.
Junior Camelid	Fri., Jul. 7	Thurs., Aug. 31	12 p.m. - 5 p.m.
Junior Clubwork	Fri., Aug. 4	Wed., Aug. 30	4 p.m. - 7 p.m..
		Thurs., Aug. 31	9:30 a.m. - 4 p.m.
Junior Goat	Fri., Jul. 7	Thurs., Aug. 31	9 a.m. - 4 p.m.
Junior Gymkhana	Fri., Jul. 7	Sat., Aug. 26	after horse show
Junior & Open Horse	Fri., Aug. 18 (Open)	Sat., Aug. 26	8 a.m.
	Fri., Jul. 7	Sun., Aug. 27	8 a.m.
Junior Poultry	Fri., Aug. 4	Wed., Aug. 30	3 p.m. - 7 p.m.
		Thurs., Aug. 31	9 a.m. - 12 p.m.
Junior Rabbits & Cavies	Fri., Aug. 4	Wed., Aug. 30	3 p.m. - 7 p.m.
		Thurs., Aug. 31	9 a.m. - 12 p.m.
Junior Sheep	Fri., Jul. 7	Thurs., Aug. 31	9 a.m. - 4 p.m.
Junior Swine	Fri., Jul. 7	Thurs., Aug. 31	9 a.m. - 4 p.m.
Open Poultry	Fri., Aug. 18	Wed., Aug. 30	3 p.m. - 7 p.m.
		Thurs., Aug. 31	9 a.m. - 12 p.m.
Open Rabbits & Cavies	Fri., Aug. 11	Wed., Aug. 30	3 p.m. - 7 p.m.
Open Youth	Fri., Aug. 11	Tues., Aug. 29	3 p.m. - 7 p.m.
Schools	Fri., Aug. 18	Sun., Aug 27	12 p.m. - 3 p.m.
		Mon., Aug. 28	3 p.m. - 6 p.m.
		Tues., Aug 29	3 p.m. - 6 p.m.

**Are you outside the Flagstaff area and have 10 or more entries for the Fair?
Check out the 2023 In-County Outreach Program (page 4) for details.
We will pick up from the following locations:**

Fredonia Public Library
Williams Public Library
Page Public Library
Grand Canyon Community Recreation Center

Livestock Show Schedule

Livestock Show	Time	Location
Saturday, August 26		
Western Horse Show	8 a.m.	Posse Arena
Gymkhana Horse Show	After Western Horse Show	Posse Arena
Sunday, August 27		
English Horse Show	8 a.m.	Posse Arena
The English show may be held on Saturday, August 26 in the afternoon if there are a small amount of participants. (exhibitors will be emailed details)		
Thursday, August 31		
ARBA Rabbit & Cavie Show	9 a.m.	Rabbit Barn
Open Rabbit and Cavies Conformation	9 a.m.	Rabbit Barn
4-H Rabbit and Cavies Conformation	1 p.m.	Rabbit Barn
Open Poultry Show	1 p.m.	Poultry Barn
Friday, September 1		
Rabbit and Cavies Showmanship	9 a.m.*	Small Livestock Show Area
Market Swine Conformation	10 a.m.	Livestock Show Ring
Poultry Showmanship and Conformation 4-H	1 p.m.	Small Livestock Show Area
Market and Breeding Beef Conformation	1:30 p.m.	Livestock Show Ring
Market Steer Showmanship	2:30 p.m.	Livestock Show Ring
Market Goat Conformation	4 p.m.	Livestock Show Ring
Market and Breeding Goat Showmanship	4 p.m.	Livestock Show Ring
Camelid Showmanship	5 p.m.	Livestock Show Ring
Market and Breeding Sheep Conformation	6:30 p.m.	Livestock Show Ring
Lamb Showmanship	6:30 p.m.	Livestock Show Ring
Sheep Breeding Showmanship	7:30 p.m.	Livestock Show Ring
Saturday, September 2		
Swine Showmanship	10 a.m.	Livestock Show Ring
Northern Arizona Junior Livestock Auction	4 p.m.	Livestock Show Ring
Sunday, September 3		
Pet, Pack, and Dairy Goat Show	10 a.m.	Livestock Show Ring
Round Robin	3 p.m.	Livestock Show Ring
Camelid Costume Show	6 p.m.	Livestock Show Ring
Monday, September 4		
Camelid Obstacle Show	10 a.m.	Livestock Show Ring
Junior Fair Awards (all 4-H members)	12:30 p.m.	Livestock Show Ring

Dates and times are subject to change. Check with the department Superintendent or the Fair Program for final schedule.

** These shows begin prior to the gates opening at 10 a.m. Only individuals with a 4-H wristband may attend prior to 10 a.m.*

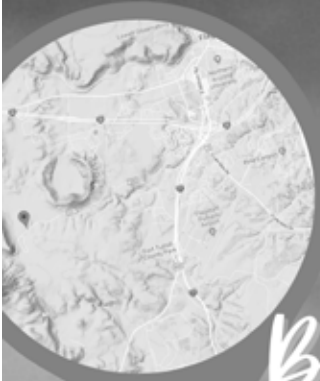

Be Prepared

**Before heading out on
your next adventure,
be prepared.**

Plan ahead and prepare

Stick to trails

Trash your trash

Leave what you find

Be careful with fire

Respect wildlife

Share the outdoors



 **COCONINO**
COUNTY ARIZONA
PARKS & RECREATION

Coconino.AZ.Gov/Parks

General Livestock Rules



Eric Treece, Livestock Coordinator
(928) 526-6346

In addition to the General Fair Rules, National Show Ring Code of Ethics, and individual department rules, the following regulations shall apply to all Junior Livestock and Open Livestock entries. Any violation of these rules may result in disqualification from the fair, removal of exhibitor and exhibits from the fairgrounds, and/or forfeiture of awards. Please read all rules carefully.

1. All rules are subject to interpretation by Coconino County Parks and Recreation [CCPR]. CCPR reserves the right to add to or amend these rules as deemed necessary. Willful violation of any Fair rules will result in disciplinary action, including refusal of entries or removal of entries from this and/or subsequent fairs.
2. All 4-H/FFA livestock departments are open to Coconino County members only. Junior livestock exhibitors must be currently enrolled, and a member in good standing, as determined by the 4-H agent or FFA Advisor.
3. Exhibitor must always have reasonable control over their animal while at the Fair. Any exhibitor who cannot maintain reasonable control over their animal will be required to remove the animal from the fairgrounds.
4. All exhibitors, parents, leaders, advisors, etc. are to conduct themselves in a proper manner. This includes proper behavior and proper dress as required by the 4-H/FFA program – no tennis shoes, open-toed shoes, t-shirts or ball caps while showing. 4-H/FFA members must conduct themselves in a showmanship manner appropriate to 4-H/FFA. Use of inappropriate language or conduct by exhibitors, parents, leaders, advisors, etc. is prohibited and is grounds for disqualification. Violation of this rule may result in expulsion from the barn, show ring, or fairgrounds.
5. If any exhibitor, or parent of an exhibitor, verbally or physically confronts a judge, that exhibitor will be disqualified, and the exhibitor (and/or parents) will be required to immediately remove themselves and the exhibit(s) involved from the fairgrounds. Awards will be forfeited. Any exhibitor, parent, leader, or fairgoer who verbally or physically confronts a judge will be required to immediately remove themselves from the fairgrounds.

6. All animals must be healthy, sound, free of drugs, and free of external parasites. No unhealthy animals will be allowed to remain on the fairgrounds and cannot be sold. If a question arises as to the health of the animal, a veterinarian will be summoned at the expense of the owner or exhibitor. Deformed and/or injured animals will not be accepted and may not be shown.
7. 4-H/FFA livestock exhibitors will be issued a wristband for four (4) days admission into the Fair and parking. In addition, they will receive two (2) 4-day admission and parking passes for two (2) parents and/or guardians to accompany the exhibitor. If a parent of an exhibitor is a 4-H Livestock Leader, then no additional passes will be issued.
8. 4-H/FFA livestock exhibitors may have two market animals of the same species in a project. Both animals must be properly identified and registered as project animals with the Northern Arizona Junior Livestock Auction Association [NAJLA] at the start of the feeding program. Only one market animal per species can be officially weighed-in at the Fair. This animal must be used by the exhibitor for all market and showmanship classes of that species. Animals sifted for weight cannot be replaced. An exception of this rule is made for Chicken Fryer Pen and Pen of Three Market Rabbits where 3 animals are weighed. and exhibitor may use another animal entered by them for showmanship.
9. NAJLA will notify all 4-H/FFA market livestock project members about animal ear tagging and/or identification. All market animals must be ear-tagged or tattooed, in the possession of and under the daily care of the 4-H/FFA member by these deadlines.
Market animal ownership deadlines and weights:

Animal	Deadline	Weight
Steer	May 1	900 lbs Min
Swine	June 15	225 lbs to 325 lbs
Sheep	June 15	90 lbs Min
Goats	June 15	60 lbs Min
Poultry	July 1	3.5 lbs to 6 lbs
Turkey	July 1	18 lbs Min
Rabbit	July 1	3.5 lbs to 5.5 lbs
10. Ownership requirement of non-market livestock is 60 days prior to opening day of the Fair. Animals must be in the exhibitor's possession and under their daily care from that date forward.
11. Entering a market animal does not guarantee that the animal will be eligible to exhibit at the Fair; exhibiting at the Fair does not guarantee that the animal will be sold; selling an animal in the auction does not guarantee that a profit will be made.
12. Animals not sold through the auction may sell out of the barns after the auction concludes. No animal may be advertised for sale prior to the conclusion of the auction. This includes 4-H/FFA and open livestock animals. Consult with department Superintendent for assistance in advertising. Exhibitors may not verbally solicit the sale of animals within barns. Exhibitors are responsible for the care, safety, and control of animals that have been sold until such animals have left the fairgrounds.

13. Livestock **MUST** be vet checked onsite by the Fair Veterinarian and checked in with the appropriate Superintendents prior to being placed in barns. The Livestock Coordinator (or designee) must be supplied all required ADAG ownership/seasonal pass papers before check-in.
 14. The Weigh-In Committee will officially weigh all market livestock entries. Animals are to be clean and dry. Large stock market animals will be weighed between 9 am - 4 pm Steers will be weighed between 3 pm - 4 pm unless previous arrangements have been made. Exhibitors must be in line for weigh-in no later than 4 pm. Exhibitors must check-in their own animals to weigh-in. Failure to weigh-in your own animal will result in the exhibitor being disqualified and the animal being removed from the Fairgrounds. Small stock market project members will be advised of small stock weigh-in procedures when their animals are checked in.
 15. Once an animal is checked in, no replacement animal will be allowed for any reason.
 16. The livestock Weigh-In Committee may consist of the Jr. Livestock Coordinator and/or their designee, the AZ Department of Agriculture, the Weigh Master, a vet, and one member of Northern Arizona Junior Livestock Auction Association. Only one parent may assist the exhibitor with getting their animal onto the scale.
 17. Market livestock will be weighed one time only. Protest or request for reweigh must be made while the animal is on the scale. The Weigh Master will balance the scale and immediately reweigh the animal. The Weigh Master will have final say.
 18. Animals that do not make weight may be shown in showmanship and feeder classes only and will not be sold through the auction. Members who do not want to show their sifted animal must remove it from the fairgrounds by 5 p.m. on weigh-in day. Animals sifted for reasons other than weight must be removed immediately from the fairgrounds.
 19. By entering your animal into the Fair, you are consenting to allow the animal to be used for Round Robin and/or the Livestock Judging Contest.
 20. To participate in the Coconino County Fair, all 4-H/FFA Market Livestock Exhibitors must have a current YQCA certification. The expiration date must not expire prior to the last day of the fair.
 21. Youth Exhibitors are responsible for the daily care and showing of their animals while at the Fair, this includes but is not limited to washing, feeding, watering, fitting, and daily cleaning of pens/bedding areas. Assistance may be provided by 4-H/FFA members currently enrolled in the Coconino County 4-H or FFA program. **Adults are not allowed to physically assist exhibitors in the daily care or preparation of the animal while at the Fair.**
 22. Large livestock exhibitors must complete morning feeding and primary clean-up of pen area before 9 a.m. each day. Barns will be open to exhibitors by 7:30 a.m. each day of the fair. After 9 a.m. there will be no unattended pans in the pens, except for water containers in the goat and sheep barns and automatic waterers in the swine barn. Evening feeding must take place before 7:30 p.m.
- All tack and feed containers should be clearly labeled with the exhibitor's name. It is also recommended that exhibitor's name be put in some obscure place on show clothes. Tools must be put away immediately after use. All tools should be clearly marked, in permanent ink, with exhibitor's name and 4-H/FFA club if applicable.
23. All exhibitors are required to completely clean out their pens, stripped to the ground, at the conclusion of the Fair.
 24. Grooming of animals will only be allowed in designated areas. Please check with the Superintendent for your department's area.
 25. Cleaning supplies and bedding will not be provided to each exhibitor. Exhibitors are expected to provide their own cleaning equipment and bedding. Poultry and Rabbit exhibitors must check with department superintendents for feeding and cleaning directions.
 26. Exhibitors **MUST** show the animals they registered for the Fair. Exceptions shall be made for people with disabilities as determined by 4-H Youth Development Agent, FFA Advisor, the Livestock Coordinator, and the Fair Manager.
 27. **MANDATORY SHOWMANSHIP:** To be eligible to sell in the auction, exhibitor **MUST** participate in Showmanship. This animal must be the animal use by the exhibitor in the market class. Chicken Fryer Pen, Turkey, and Market Rabbits are excluded, these exhibitors may use another animal entered by them for showmanship.
 28. **FOR ALL SPECIES:** Drenching - No item or device shall be inserted into an animal's mouth with the intent to force the animal to ingest liquid/food/substance except as necessary for medical care under the direction of the Fair veterinarian and staff authorization. Animals may be assisted in hydrating (using water or species approved/ labeled electrolytes) with bottles, sprayers, non-intrusive device labeled for that species- as long as nothing is inserted more than two inches inside the animal's mouth and no airways are blocked (can't cover their nose to make them swallow).
 29. No chemicals (except those approved in writing by the Fair management) shall be used within livestock pens or barn areas.
 30. Exhibitors who live more than 50 miles away from Flagstaff area (i.e. Page, Tuba City, etc.) may start loading and remove exhibits from the Fairgrounds at 2:30 p.m. on Monday. This is for all species of Livestock (large and small), and 4-H Club Work. All exhibits **MUST** be returning to the exhibitor's residence. No vehicles will be allowed on the Fairgrounds before 4 p.m. If Large Livestock is removed, exhibitor must meet barn clean-up rules before departure. Animals sold in the auction cannot be removed from the Fairgrounds prior to 4 p.m. on Monday.
 31. Exhibitors and their families must follow all rules and policies set forth in the International Fire Code per the State Fire Marshal. Common infractions include gasoline storage, location of generator, and location of pop-up tents.

Any violation of General Livestock rules may result in disqualification from this Fair or future Fairs.

Barn Duty For 4-H/FFA Members

Barn duty is a requirement of every 4-H/FFA member with an entry. Sign-up sheets will be posted prior to Fair opening and is the exhibitor's responsibility to sign-up for barn duty as required by Department Superintendent. Failure to sign-up or not show up for barn duty will result in disciplinary actions.

Barn duty consists of:

1. Being in the barn or outside pens while on duty.
2. Greet the public coming into the building.
3. Monitor animals on exhibit for safety and general condition.
4. Interact with the public by answering questions or explaining things about the animals.
5. Pick up trash and dispose of it.
6. Help maintain cleanliness and neatness of area.

Many Thanks To Our 2022 Volunteers!

Nicole Brendel
Sheri Brendel
Rick Parker
Laura Parker

Many Thanks To Our 2022 Sponsors!

Eric & Charolette Treece
Olsen's Grain
Aspen Veterinary Clinic

THANK YOU Aspen Veterinary Clinic

**for your dedication to the
Coconino County Fair!**

~ We appreciate your support ~

Junior Livestock Exhibitor Grievance Procedures

In order for the Coconino County Fair to function efficiently, a grievance procedure and committee has been developed to rule on all grievances, protests or appeals related to Junior livestock departments. The Grievance Committee shall consist of the Fair Manager or Designee, Cooperative Extension Representative, the Livestock Coordinator, a 4-H or FFA leader, and a Fair Superintendent. Any members of this committee with a conflict of interest shall recuse themselves.

The Grievance Committee shall be assembled in such a way that no participant will have a conflict of interest in serving on the committee. Decisions of this committee will be by consensus and will be final.

A grievance or protest can only be filed by an exhibitor. The Grievance Committee will consider no protest or appeal based upon the statement that the judge or judges are incompetent or have overlooked an animal. The right of an exhibitor to appeal the decision of the judge to the Grievance Committee will lie only when it is charged that the award has been made in violation of the rules governing the exhibit, or when it is charged the decision of the judge has been influenced or interfered with by another. All questions in dispute, or differences not covered by General Fair Rules, The National Show Ring Code of Ethics for the Coconino County Fair General Livestock Rules, or the Junior Livestock Rules shall be referred to the Grievance Committee whose decision shall be final.

All protests must be made to the Grievance Committee within one hour of the occurrence in question. The Grievance Committee will attempt to make a decision regarding the grievance within two hours after having received the written grievance.

The procedure to file a grievance is as follows:

1. Exhibitor shall notify the department Superintendent where the problem exists to allow discussion and possible resolution prior to filing a written grievance.
2. If the situation cannot be resolved, exhibitor must compose a statement regarding the grievance. A complete Grievance Statement shall contain:
 - a. Date
 - b. Time
 - c. Problem
 - d. Signatures the exhibitor, their parent/guardian, the Department Superintendent, and the Livestock Coordinator
 - e. Phone numbers and/or e-mail addresses of said parties
 - f. Desire or not to present grievance to the Grievance committee
3. The Grievance Statement must be given to the 4-H or FFA Youth Development Staff.
4. The Grievance Committee will meet with the Superintendent for further discussion and clarification.
5. The Grievance Committee will be assembled and will then meet privately to discuss the grievance and make a final decision. The final decision will be based on committee consensus.
6. Persons submitting and/or persons upon whom a grievance has been submitted may present their case to the Grievance Committee. Presenters will be given 10 minutes each. The desire to present to the Grievance Committee shall be so noted in the Grievance Statement. Presenters must make themselves available to present to the committee when the committee meets and will be notified as to when said meeting will take place.
7. Exhibitors will receive a written statement back from the Grievance Committee and will be told of the Committee's decision verbally by the 4-H or FFA Youth Development Staff.



Round Robin Showmanship Procedures

Junior and Senior 4-H/FFA members who win a Showmanship class are eligible to compete in Round Robin and Supreme Round Robin Showmanship. Any Junior or Senior 4-H/FFA member who wins more than one Showmanship class must decide which species they wish to show in and notify the Livestock Coordinator immediately after the last showmanship class the exhibitor is participating in.

The Reserve Showman of the species not chosen by the Grand Champion Showman will then be eligible to compete in Round Robin. Two animals from each species will be at each station. There will be a small stock as well as a large stock Round Robin competition. Showmen may compete in either or both competitions.

All showmen who wish to compete for Supreme Round Robin Showmanship must show all species present in small stock and large stock Round Robin. Small stock can include Rabbit, Cavy, and Poultry. Large Stock can include Camelid, Market Swine, Market/Breeding Sheep, Market/Breeding Goat, Dairy/Non-Dairy Goat, Market Beef, Jr. Breeding Cattle, English Horse Showmanship, and Western Horse Showmanship. To qualify for Round Robin, each class must have at least two Showmanship entries per division (Jr. Sr.). Novice Showmanship is NOT included in Round Robin Showmanship.

Junior and Senior large and small stock Round Robin showmanship winners will be determined using a point system. The Junior and Senior Supreme Showman will be selected using a combined score of large stock, small stock species and written knowledge challenge.

1. Showmen must show the same animal that was used in the showmanship class in which they won Champion Showman or Reserve Champion Showman.
2. Each species will have appointed stations in the show ring. For example; the Junior Showman will have his/her animal at a station and the Senior Showman will have the same species at that station. (Each station may have two animals of the same species.)
3. Showmen will have about five minutes at each station and will rotate around the show ring until they have shown each species.
4. Each station will have two judges, a Junior Judge and a Senior Judge. Each judge will use a scorecard to judge each Showman.
5. There will be a Junior Round Robin Champion and a Senior Round Robin Champion. A Junior and Senior Supreme Round Robin Showman will be selected from the 4-H/FFA Showman who has the most points between small and large stock for their respective age division.

Showmen are not required to show both large and small stock. However, those who choose to compete for Supreme Round Robin Showman will need to compete in both large and small stock.

6. Blank scorecards will be available for review in each livestock barn.

Round Robin Showmanship Awards

Sr. Supreme Round Robin Showman:	Buckle
Jr. Supreme Round Robin Showman:	Buckle
Sr. Small Stock Round Robin Showman:	Award
Jr. Small Stock Round Robin Showman:	Award
Sr. Large Stock Round Robin Showman:	Award
Jr. Large Stock Round Robin Showman:	Award

Junior Herdsmen Award Procedures

Each Junior Livestock department offers one Junior Herdsman Award based on the following criteria:

1. Neatness, attractiveness and cleanliness of exhibitor's pens and surrounding area.
2. Condition and appearance of exhibitor's animals throughout the Fair, and the level of care and attention given to his/her animals.
3. Interaction with fairgoers, educational exhibit or presentation in the barn.
4. Friendliness and cooperation with staff and fellow exhibitors.

Show Ring Code of Ethics

Exhibitors of animals at livestock shows shall at all times deport themselves with honesty and good sportsmanship. Their conduct in this competitive environment shall always reflect the highest standards of honor and dignity to promote the advancement of agricultural education. This code applies to junior as well as open class exhibitors who compete in structured classes of competition. This code applies to all livestock offered in any event at a livestock show. In addition to the "IAFE Code of Show Ring Ethics," fairs and livestock shows may have rules and regulations which they impose on the local, county, state, provincial and national levels.

All youth leaders working with junior exhibitors are under an affirmative responsibility to do more than avoid improper conduct or questionable acts. Their moral values must be so certain and positive that those younger and more pliable will be influenced by their fine example. Owners, exhibitors, fitters, trainers and absolutely responsible persons who violate the code of ethics will forfeit premiums, awards and auction proceeds and shall be prohibited from future exhibition in accordance with the rules adopted by the respective fairs and livestock shows. Exhibitors who violate this code of ethics demean the integrity of all livestock exhibitors and should be prohibited from competition at all livestock shows in the United States and Canada.

The following is a list of guidelines for all exhibitors and all livestock in competitive events:

1. All exhibitors must present, upon request of fair and livestock show officials, proof of ownership, length of ownership, and age of all animals entered. Misrepresentation of ownership, age, or any facts relating thereto is prohibited.
2. Owners, exhibitors, fitters, trainers, or absolutely responsible persons shall provide animal health certificates from licensed veterinarians upon request by fair or livestock show officials.
3. Junior exhibitors are expected to care for and groom their animals while at fairs or livestock shows.
4. Animals shall be presented to show events where they will enter the food chain free of volatile drug residues. The act of entering an animal in a livestock show is the giving of consent by the owner, exhibitor, fitter, trainer and/or absolutely responsible person for show management to obtain any specimens of urine, saliva, blood, or other substances from the animal to be used in testing. Animals not entered in an event which culminates with the animal entering the food chain shall not be administered drugs other than in accordance with applicable federal, state and provincial statutes, regulations and rules. Livestock shall not be exhibited if the drugs administered in accordance with federal, state and provincial statutes, regulations and rules affect the animal's performance or appearance at the event. If the laboratory report on the analysis of saliva, urine, blood, or other sample taken from livestock indicates the presence of forbidden drugs or medication, this shall be prima facie evidence such substance has been administered to the animal either internally or externally. It is presumed that the sample of urine, saliva, blood, or other substance tested by the laboratory, to which it is sent, is the one taken from the animal in question, its integrity is preserved and all procedures of said collection and preservation, transfer to the laboratory and analysis of the sample are correct and accurate and the report received from the laboratory pertains to the sample taken from the animal in question and correctly reflects the condition of the animal at the time the sample was taken, with the burden on the owner, exhibitor, fitter, trainer, or absolutely responsible person to prove otherwise. At any time after an animal arrives on the fair or livestock show premises, all treatments involving the use of drugs and/or medications for the sole purpose of protecting the health of the animal shall be administered by a licensed veterinarian.
5. Any surgical procedure or injection of any foreign substance or drug or the external application of any substance (irritant, counterirritant, or similar substance) which could affect the animal's performance or alter its natural contour, confirmation, or appearance, except external applications of substances to the hoofs or horns of animals which affect appearance only and except for surgical procedures performed by a duly licensed veterinarian for the sole purpose of protecting the health of the animal, is prohibited.
6. The use of showing and/or handling practices or devices such as striking animals to cause swelling, using electrical contrivance, or other similar practices are not acceptable and are prohibited.
7. Direct criticism or interference with the judge, fair or livestock show management, other exhibitors, breed representatives, or show officials before, during, or after the competitive event is prohibited. In the furtherance of their official duty, all judges, fair and livestock show management, or other show officials shall be treated with courtesy, cooperation and respect and no person shall direct abusive or threatening conduct toward them.
8. No owner, exhibitor, fitter, trainer, or absolutely responsible person shall conspire with another person or persons to intentionally violate this code of ethics or knowingly contribute or cooperate with another person or persons either by affirmative action or inaction to violate this code of ethics. Violation of this rule shall subject such individual to disciplinary action.
9. The application of this code of ethics provides for absolute responsibility for an animal's condition by an owner, exhibitor, fitter, trainer, or participant whether or not he or she was actually instrumental in or had actual knowledge of the treatment of the animal in contravention of this code of ethics.

10. The act of entering an animal is the giving of consent by the owner, exhibitor, fitter, trainer, or absolutely responsible person to have disciplinary action taken by the fair or livestock show for violation of this Code of Show Ring Ethics and any other rules of competition of the fair or livestock show without recourse against the fair or livestock show. The act of entering an animal is the giving of consent that any proceedings or disciplinary action taken by the fair or livestock show may be published with the name of the violator or violators in any publication of the International Association of Fairs and Expositions, including Fairs and Expos and any special notices to members.
11. The act of entering of an animal in a fair or livestock show is the giving of verification by the owner, exhibitor, fitter, trainer, or absolutely responsible person that he or she has read the IAFE Code of Show Ring Ethics and understands the consequences of and penalties provided for actions prohibited by the code. It is further a consent that any action which contravenes these rules and is also in violation of federal, state, or provincial statutes, regulations, or rules may be released to appropriate law enforcement authorities with jurisdiction over such infractions.

Other cooperating shows will be notified of the action taken by Show Management, which may affect the eligibility of the individual, group or sponsoring organization for participation at other shows. Coconino County Parks and Recreation will have the final decision.



Learn more about the International Association of Fairs and Expositions (IAFE) at their website, www.FairsandExpos.com.

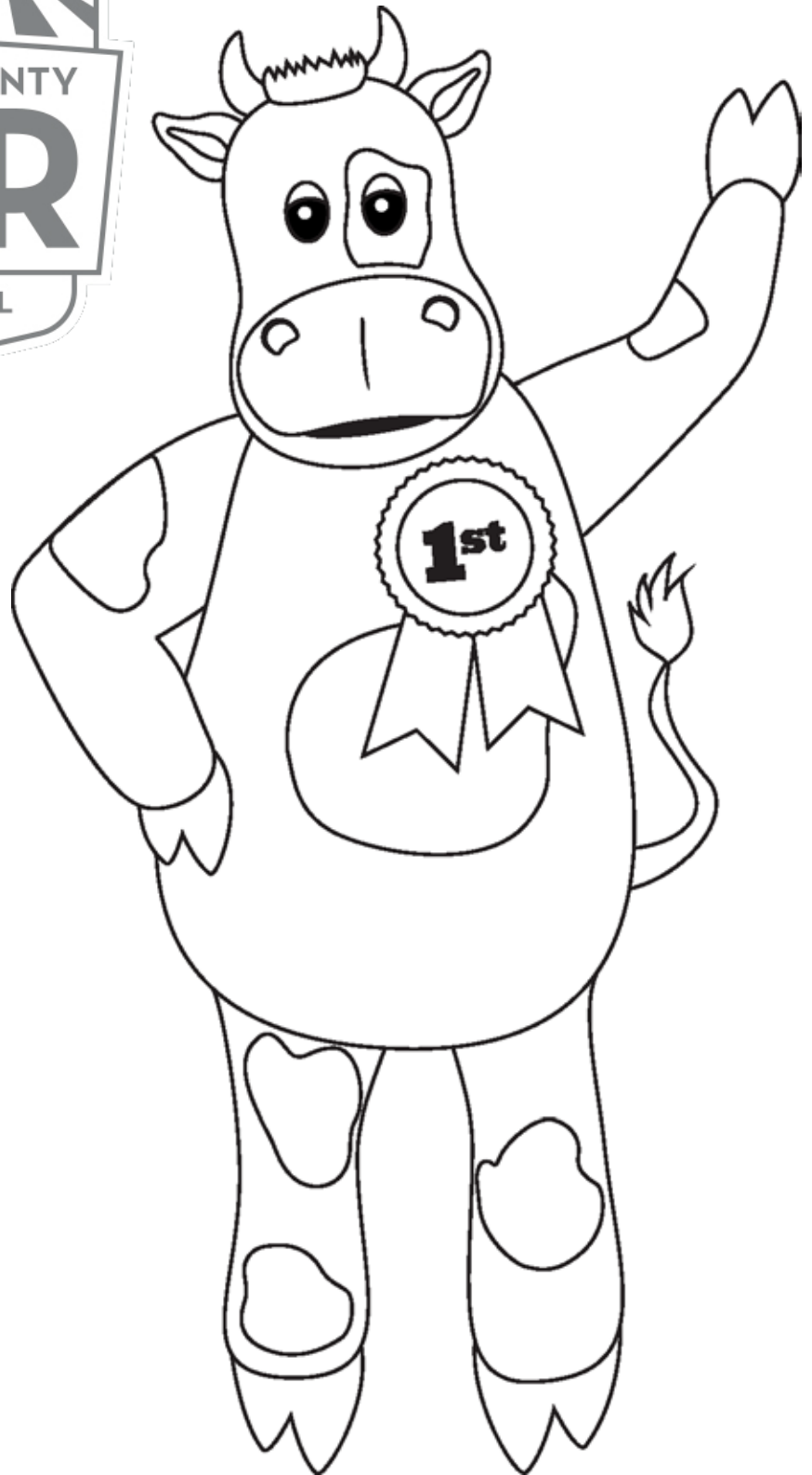



NORTHERN ARIZONA JUNIOR LIVESTOCK ASSOCIATION

2022 SCHOLARSHIP RECIPIENT

ALLY HUBBARD

THANK YOU *Chick-fil-e* OF FLAGSTAFF

2022 OFFICIAL SPONSORS



2022 LIVESTOCK TENT SPONSOR



2022 BBQ SPONSOR

COCONINO COUNTY FARM BUREAU & CATTLE GROWERS' ASSOCIATION

2022 PURPLE RIBBON SPONSORS



2022 BLUE RIBBON SPONSORS



PERRIN RANCH



BABBITT RANCHES



2022 RED RIBBON SPONSOR



OUR SUPPORTERS

Rick & Laura Parker - Mangum, Wall, Stoops, & Warden PLLC - Aspen Veterinary Clinic

NAJLA BOARD OF DIRECTORS

Mike Mangum - President Brooks Cameron - Vice President Kodi Mortensen - Treasurer Sherri Brendel - Secretary JW Dyer - Troy Mortensen - Kristi Bennett - Megan Treece - Bailee Cameron - Ethan Johnson

Thank you to our

2022 buyers!



Adonia Yachts
 Amber Wollman
 Amy Barrerra
 Arizona Mobile Meat Processing
 Aspen Veterinary Clinic
 Auza Contracting Inc
 AZ Materials
 B3 Construction
 Bar T Bar Ranch
 Big John's Texas BBQ
 Bleeker's Boxes
 Bohunk Excavating
 Buffalo Fence & Barn Co.
 Builders Showcase Inc
 Cal Ranch
 Camelia Gembala
 Capstone Homes
 Coconino Farm Bureau
 Consolidated Electrical Distributors
 Copper Electric
 Dr. Susan Crawford DVM
 Law Office Of Tony S. Cullum
 Dam Outlet
 DBA Construction
 Diversified Financial Services, Inc
 Doug Whitehead
 Dr. Douglas Lee

Eagle KMC LLC
 Feral Iron Works
 Foxboro Ranch
 Hunter Building Group
 Jim and Vickie Parks
 Jolly Rogers Upholstery
 Lake Powell Construction
 Lake Powell Furniture
 Lake Powell Realty
 Landscape Connection
 Major League Painting
 Melissa Klemp
 Melvin Consulting PLLC
 Michael Budagher
 Nate Watson
 P&M Trailer Sales
 Page Eye Center
 Paria River Ranch
 Perrin Ranch
 Riggs Welding
 Royal Hop Company
 Rummel Construction
 Staple 3 Construction LLC
 Surf Lake Powell, LLC.
 Todd & Donna Teigan
 Valhalla

Rogers Custom Heating & Cooling LLC

See you in 2023!

**2023 COCONINO COUNTY FAIR
SATURDAY, SEPTEMBER 2, 2023**

2:00 P.M. REGISTRATION BEGINS
 2:00 P.M. BUYER'S BBQ
 4:00 P.M. AUCTION TIME!

2022 Coconino County Fair Grand Champions



Tyler Pouquette
Purchased for \$14,080
Capstone Homes



Triniti Taylor
Purchased for \$5,020
Valhalla



Tyler Pouquette
Purchased for \$1,605
Perrin Ranch



Landon Meredith
Purchased for \$1,164
Aspen Veterinary Clinic



Joshua Curnes
Purchased for \$1,000
DBA Construction



Carter Mock
Purchased for \$1,200
Adonia Yachts

2022 Coconino County Fair Reserve Champions



Daisy Howell
Purchased for \$11,178
Douglas Lee



Ellie Cameron
Purchased for \$3,132
Melissa Klemm



Ava Smith
Purchased for \$2,160
Foxboro Ranch



Piper Mangum
Purchased for \$1,066
Dan Outler



Lucy Walton
Purchased for \$1,000
Melvin Consulting PLLC



Morgan Mock
Purchased for \$850
Hunter Building Group

NORTHERN ARIZONA JUNIOR LIVESTOCK ASSOCIATION, INC.

AUCTION RULES

These rules give an overview of the auction and exhibitor requirements. An exhibitor's entry into the livestock auction represents an explicit agreement by the exhibitor and the exhibitor's parent, or guardian, with all of the following rules and penalties. All animals intended for human consumption offered for sale in the auction must 1) meet residue tolerances established by USDA/FDA and 2) be free of any substance not approved of by the USDA/FDA (www.usda.gov). NAJLA is not part of 4-H, FFA or the Coconino County Fair. These rules and their enforcement are totally separate from 4-H/FFA.

All questions regarding the Junior Livestock Auction Rules and exhibitor requirements should be addressed to;

NAJLA PO BOX 3472 FLAGSTAFF, AZ 86003
(435) 632-9968
www.najlasite.org

I. GENERAL RULES

The Junior Livestock Auction (Auction) is under the supervision of the Northern Arizona Junior Livestock Association, hereafter referred to as NAJLA. The Auction is limited to Market Steers, Market Lambs, Market Swine, Market Goats, Rabbit Meat Pens, Chicken Fryer Pens, and Market Turkeys. NAJLA has the sole authority in the interpretation and enforcement of the Auction rules.

A. NOTIFICATION:

1. NAJLA reserves the right to test any animal officially entered in any division eligible to sell in the Auction, for any substances including drugs/medications or feed additives.
2. For the Coconino County Fair, at a minimum, the Grand and Reserve Champion market livestock (steers, lambs, swine, and goats) will be tested. Tissue, blood and urine samples **may** be collected. Blood and urine samples will be collected as soon as possible after the Grand and Reserve Champions are selected and/or as required. Other animals entered in the market shows **may** be tested. Sale money will be withheld until tests are completed.
3. WITHDRAWAL OF LIVESTOCK FROM AUCTION:
Exhibitors who want to withdraw their market animal from the Auction must complete a Withdrawal Slip available from a Barn Superintendent. Return form to a NAJLA board member by 6:00 pm on the evening **prior** to the auction. If you do not fill out this form and return it by the deadline, you will be required to sell your animal in the auction. If you fail to bring your animal into the auction, or if you remove your animal from the sale ring before the sale is complete, you will be prohibited from selling at future NAJLA coordinated events including the Auctions.
4. Only the exhibitor & the exhibitor's animal are allowed in the Sale Ring during the auction. **Exception:** an exhibitor is allowed to have help from current 4-H/FFA members to carry rabbit meat pens, and chicken fryer pens.
5. Animals are not the responsibility of NAJLA, Coconino County, the Coconino County Fair or Cooperative Extension. Each exhibitor is responsible for the care and feeding of all project animals until they are released by the Superintendent on the last day of the Coconino County Fair at 4:00 pm.
6. NAJLA reserves the right to make deductions from any exhibitor's sale to cover outstanding balances that have been generated by other family or household members associated with the exhibitor.

7. PER COCONINO COUNTY FAIR LIVESTOCK RULES, MARKET ANIMALS MUST BE OWNED AND IN THE EXHIBITOR'S POSSESSION BY:

STEERS - May 1
SWINE, LAMBS, & GOATS - June 15
TURKEYS, RABBITS & POULTRY PENS - July 1

NAJLA ONLINE REGISTRATION and W9's MUST BE COMPLETED on or before:

STEERS- May 9
SWINE, LAMBS, & GOATS- June 22
TURKEYS, RABBITS & POULTRY PENS- July 9

EXHIBITOR ENTRY AND SIGNATURE RELEASE FORM, W9, as well as photos must be uploaded with online entry to complete your registration.

8. LATE REGISTRATION NOTICE: ONLINE Market Registrations received after the deadline; but no later than one week, will be charged a late fee of \$100.00 PER Large Stock Exhibit, and \$50.00 PER Small Stock Exhibit.

9. BACK-UP ANIMALS: Immediate family members may register the same Back-Up animal, not to exceed 2 registered animals per exhibitor, per species.

B. NUMBER OF ANIMALS TO BE SOLD:

1. Exhibitors will be allowed to sell two different lots, or animals, in the Auction.
2. All Grand and Reserve Champion steers, lambs, swine, goats, turkeys, rabbit meat pens and chicken fryer pens **must** sell.
3. In the event that you have 2 or more Champions, you may sell one additional animal.

4. EXHIBITOR DRESS CODE:

Exhibitor Dress Code for entry in the sale ring shall be as follows:

For 4-H Exhibitors:

Pants or jeans: that are dark blue or black in good condition.

Shirt: A white long or short sleeved shirt, with a collar. 4-H green tie, scarf, 4-H vest, 4-H Club jackets in 4-H colors are permitted, but not required.

For FFA Exhibitors:

Bottoms: black skirt, black slacks, or black jeans in good condition. Only black nylon hosiery will be permitted.

Tops: white collared blouse and official FFA blue scarf or blue or black tie. Official FFA jacket must be worn and zipped to the top.

Shoes: Black dress shoes with closed heel and toe.

No other jackets, vests, sweatshirts or sweaters are to be worn. No baseball hats, caps*, tiaras, crowns, sunglasses, sandals, tennis shoes or open toed shoes are to be worn. Exceptions for religious reasons will be considered. Animals and/or exhibitors may not be decorated; bows, glitter, graffiti, costumes, etc. except for ribbons, buckles, received during the fair. Failure to comply with the standard of presentation may result in not being able to enter the sale ring to sell your animal.

***Cowboy hats will be allowed.**

D. EXHIBITOR RESPONSIBILITIES DURING AUCTION:

- Exhibitors must take their own animal through the auction ring except in unusual circumstances, such as sickness, family emergency. Extra-curricular activities will not be considered an exception. Only currently enrolled Coconino County 4-H and Coconino County FFA members exhibiting at the current Coconino County Fair may serve as a substitute, with the approval of the NAJLA Executive Board.
- Exhibitors who fail to be at the auction ring in the proper sequence will not be allowed to sell their animals through the auction and must remove their animals from the fairgrounds on the final day of the Coconino County Fair after 4:00 pm; or personally consign them to a packer through NAJLA. Commission will be charged for all animals consigned.
- Exhibitors are required to send their buyer a thank you letter by October 31, of the current year; this is in addition to any optional gift given to your buyer at the Auction.
- Exhibitors who fail to properly feed and water their animal(s) and maintain their pen after the auction will be fined and will forfeit all monies received and will not be able to sell at future NAJLA coordinated events including the Auctions. Buyer will still receive their purchased animal and monies will go to the auction committee fund.

II. LIVESTOCK RULES

A. All General Fair Rules, General Livestock Rules, Junior Livestock Rules and NAJLA Auction Rules apply.

B. WEIGH-IN & CHECK-IN:

- Only one registered Market animal per species can be officially weighed-in. Animals sifted for weight cannot be replaced with another registered Market animal.
- WEIGH IN:**

a. LARGE STOCK

All large stock market animals will be weighed by the Weigh-In Committee on the Thursday before the first day of the Coconino County Fair between 9:00 am and 4:00 pm. Scales will close at 4:00 pm.

- STEERS, LAMBS, SWINE, AND GOATS** must provide an Arizona Seasonal Pass.

Classification is to be determined by the exhibitor when submitting your Ear Tag Registration Form. Correctly identifying and declaring your animal's breed is your responsibility. Consult with your project leader for correct classification. Breed will be confirmed by an Official Classifier.

b. SMALL STOCK

Small Stock animals will be checked-in and weighed on the Wednesday, before the first day of the Coconino County Fair between 3:00 pm and 7:00 pm or the Thursday, before the first day of the Coconino County Fair between 9:00 am and 12:00 pm.

c. Animals must be clean and dry at time of weigh-in. Exhibitors must take their own animal to weigh-in. Failure to weigh-in your own animal will result in the animal and exhibitor being disqualified and the animal must be removed from the Fairgrounds.

d. Market Livestock will be weighed one time only. Protest or request for reweigh must be made while the animal is on the scale. The Weighmaster will balance the scale and immediately reweigh the animal and take that weight as the final weight. The Weighmaster will have final say on the weight.

e. Animals that do not make weight may be shown in Showmanship and Feeder Classes only, and will not be sold through the Auction.

f. SMALL STOCK Market Exhibitors will be advised of Small Stock weigh-in procedures when they check-in with their respective Barn Superintendent.

C. SALE PROCEDURE/RIBBON:

Market steers, lambs, swine, goats, turkeys, rabbit meat pens and chicken fryer pens will be sold at the Auction on the Saturday of the fair. BLUE, RED AND WHITE Ribbon awarded animals will be sold. **Animals deemed not "Market Ready" by the judge, will not sell at the Auction.**

- Exhibitors will be paid for the maximum sale weight of:

Swine:	300 pounds
Lambs:	150 pounds
Steers:	1350 pounds
Goats:	150 pounds

- Auctioneer(s) will be provided by NAJLA.
- Sale order will be determined by NAJLA.
- Checks will be sent by the NAJLA Treasurer to the exhibitor when adequate funds are available (at least 8 weeks after the conclusion of the auction). Adequate funds are defined as enough money collected to cover all exhibitors' checks, and other liabilities incurred by NAJLA in administering the Auction.
- PERCENTAGES & FEES:** There will be an Administrative Fee not to exceed; 4% on beef and 6% on swine, lamb, goats and small stock on all animals that sell through the Auction. Funds received from fees shall be used by NAJLA. In addition, a fee will be deducted from each exhibitor's check for any national steer/lamb/swine Check-Off program and livestock inspections (as required).

An Exhibitor Fee not to exceed \$20 for steer, swine, lamb, and goat and, \$10 for small stock, will be deducted from each exhibitor's check. In the event that a sale check needs to be re-issued because it was lost or outdated, the exhibitor will be charged the stop payment fee for the original check.

D. EXHIBITOR'S RESPONSIBILITIES: FOREIGN SUBSTANCE

- It is the exhibitor's responsibility to submit a market animal intended for human consumption with 1) residue tolerances within guidelines established by USDA/FDA and 2) be free of any substance not approved of by the USDA/FDA. Exhibitors and their families should exercise special care when administering any products to or on their animals. **DO NOT USE** over the counter products made for human consumption or use. Use only products labeled as acceptable for species-specific market animal use. Other products may produce a residue in the meat and render the carcass unacceptable by the USDA/FDA. NAJLA reserves the right to require the exhibitor to submit the appropriate documentation proving that the animal is residue free or pay for the required testing.
- The exhibitor and/or immediate family must notify the Weighmaster of ANY substance which was administered to the animal prior to arrival at the Coconino County Fair and which has not met the required withdrawal period for that substance. These include, but are not limited to: growth stimulants, drugs/medication, and/or feed/water additives (i.e. antibiotics, wormers). Notification must be made in writing prior to check-in/weigh-in/penning of animal at the Coconino County Fair. The Superintendent will notify the President of NAJLA of the declaration.

3. If it is necessary to administer any USDA/FDA approved species-specific market animal drug/medication, during the time market livestock projects are housed at the Coconino County Fair, NAJLA must be notified in writing prior to any administrations. If situations warrant, such as medical emergency, that a NAJLA Executive Board member cannot be notified prior to administration of drug/medication, or feed/water additive, the exhibitor and/or his/her immediate family must notify the NAJLA within ten (10) hours of administration of drug/medication, or feed/water additive except in cases immediately prior to the auction, when notification *must take place prior to the animal entering the sale ring*. Exhibitor will notify the Executive Board of NAJLA of the declaration.
4. If any animal is being treated with USDA/FDA approved species specific market animal drug/medication and a delayed market date is needed to ensure a residue free carcass, it is the exhibitor's responsibility to ensure that appropriate announcement of the *delayed market requirement* is submitted in writing with the prescribed requirement to NAJLA prior to entering the sale ring. The exhibitor will then be responsible for maintaining the animal until it is residue free and then delivering the animal to the designated location (packer, buyer etc.) Grand and Reserve Grand Champion animals requiring a delayed slaughter date will be treated on an individual basis with special handling as required.
5. Sale money will be withheld until tests are complete.
6. *Exhibit Sale Disposition:* If it is proven that an animal has received or tests report the positive presence of drugs/medication, or feed/water additive(s) not approved by the USDA, FDA, or above the USDA guideline residue levels and/or not in compliance with the USDA Wholesome Meat Act, in any test or procedure, that animal will be disqualified and the exhibitor declared ineligible to receive sale proceeds or packer monies (if applicable). The carcass of a disqualified animal will be disposed of per instructions from USDA or FDA or the State of Arizona. The Buyer will be given the option to void the purchase or accept a replacement carcass of equal value. However, in either event the exhibitor **will not** receive any of the proceeds. If any entry is disqualified because of USDA Wholesome Meat act, all disqualifications can be applied.
7. If substances or residues, including drugs/medications, or feed/water additives, as defined above, are found in the tissue of the carcasses of animals entered/sold through the NAJLA sale, NAJLA will in no way be held liable or responsible for condition of carcass or sale price of animal. Further, the exhibitor and his/her family will indemnify and hold harmless NAJLA and all of its sponsors and assisting organizations, their employees and agents, against all legal or other proceedings in connection with said drug testing. The exhibitor and his/her family will indemnify and hold harmless the show and its sponsors and assisting organizations against all claims for injury to any person or property caused by any animal and/or its meat.

8. If the exhibitor's animal is condemned for anything other than illegal drug use, the Buyer has the option to refuse the product and void the purchase or accept a replacement carcass of equal value at the exhibitor's expense. If buyer voids the sale and refuses a replacement carcass, the exhibitor receives no compensation and may be liable for costs incurred.

E. EXHIBITOR'S PENALTIES:

If animals intended for human consumption are found with 1) residue tolerances **not** within guidelines established by USDA/FDA, 2) substances not approved of by the USDA/FDA and/or 3) if the substance is approved and the exhibitor fails to meet the requirements of withdrawal times and/or 4) fails to declare any medication and/or feed/water additives that have not met USDA/FDA withdrawal times at check in:

1. Exhibitor will be barred from consigning any/all animals at any NAJLA coordinated events including Auctions.
2. Exhibitor will forfeit all auction sale money associated with the contaminated animal and be subject to all disposal charges.
3. Anyone caught tampering per the above substance abuse violation with their own or another animal will be prohibited from the sale.
4. A written request for an appeal of the ban from the sale can be submitted to NAJLA.

III. EXHIBITOR INCIDENT AND GRIEVANCE

The NAJLA Grievance Committee will only accept grievances that relate to procedures, rules and incident's that are under the management of the Northern Arizona Jr. Livestock Association. Grievances relating to livestock shows and individual livestock barn issues should be directed to the Coconino County Fair Superintendent for the specific barn. The NAJLA Grievance committee is a five-member committee whose members have no family relationship to a current 4-H Market Livestock Exhibitor.

A grievance must be written on a NAJLA Exhibitor Incident and Grievance Form, available from a NAJLA committee member or Barn Superintendent, and given to the NAJLA Grievance Committee Chairperson within three hours of a protested occurrence. A grievance may only be filed by a market livestock exhibitor. Grievances will be adjudicated by the NAJLA Grievance Committee whose decision is final, and their decision will be made known to all parties involved within three hours of receipt of the Exhibitor Grievance Form. The NAJLA Grievance Committee will read the grievance as presented by the exhibitor. NAJLA reserves the right to discuss the grievance with anyone they deem necessary in resolving the grievance, including, but not limited to all parties named in the grievance. Upon request you may receive a copy of the form, and a copy of the written decision.



2023 Coconino County Fair

Northern Arizona Junior Livestock Association Auction

Saturday, September 2, 2023

2:00 p.m.
2:00 p.m.
4:00 p.m.

Registration Begins
Buyer's BBQ
Auction Time!

www.najlasite.org

Agriculture & Horticulture

Department Code "AH"



Nick Lipinski, Superintendent
(928) 380-3692



Galen Guerrette, Superintendent
(928) 600-2298

Entry Fee: \$0.00 / entry

Entry Forms Due: August 18

Receiving Date: August 30, 10 a.m. - 7 p.m.

Release Date: September 4, 4 - 6 p.m.

Department Rules

1. All General Fair Rules apply.
2. Only exhibits from Coconino County will be eligible for competition and awards. **Only one entry per Class.**
3. Hot house or hydroponic grown vegetables will be judged separately, see appropriate category.
4. Classes reading "ANY OTHER VARIETY NAMED" must be named or they will not be judged. Write variety name on your entry form. Every year gardeners grow new varieties not listed in the Fair Book. While we make every effort to include as many new varieties as possible, some are not listed. It is not possible for the Fair to add Classes at entry time. We have tried to make provisions to accept as many of the unlisted items as possible and will assist you in trying to find the appropriate category. If a category cannot be found, we invite you to leave the item as a display item (showing that the variety can be grown here), and it may be added to the following year's Fair Book.
5. All Classes judged on a MARKET standard of size, uniformity and presentation.
6. Youth Age Group - Open to Coconino County residents under 18 years of age as of July 31, 2023. Rules and Classes are the same as for adults. Please write "Y" for youth, in the division code column. Pictures of children

in their garden are requested for decorating the building. Please bring pictures during exhibit entry and they will be returned at entry pick up time. Please write name and phone number on back of pictures.

7. Exhibitors submitting five or more entries will receive one 1-day admission to the Fair.
8. Judging results submitted by judges and department Superintendents are considered final.
9. Ribbons will be awarded according to merit. All the items are judged against items in the same Class.

Division Codes

(A) - Adult (over 18 years old)

(Y) - Youth (under 18 years old)

Awards

First: Ribbon, Second: Ribbon, Third: Ribbon

Best of Show:

Adult: \$25

Youth: \$25

Field Crops: \$25

Vegetable or Truck Crops: \$25

Garden Collection: \$25

Fruit: \$25

Herbs: \$25

Eggs: \$25



Sponsored by
**Friends of Coconino
County Parks**

Youth Best:

Truck Crops: \$20

Garden Collection: \$20

Fruit: \$20

Herbs: \$20

Eggs: \$20



Sponsored by
The Cromer Family

Field Corn - Dry Ear Corn (6 ears shucked)

Class	Description
100	Flint, any
101	Mexican June
102	Miniature Corn, any variety, named
103	Squaw or Indian Corn
104	White Dent, any other
105	Yellow Dent, any other
106	Flour corn or any soft
107	Popcorn, any other variety, named
108	Popcorn, Blue, any variety
109	Popcorn, Red Rice
110	Popcorn, Smooth White
111	Popcorn, Smooth Yellow
112	Popcorn, Strawberry Red
113	Popcorn, Strawberry White
114	Popcorn, White, Rice

Grass and Legume Seeds (1 Quart)

Class	Description
115	Amaranth, name variety
116	Barley, any variety
117	Beans, Aztec, White
118	Beans, Black
119	Beans, Brown
120	Beans, Lima, Colored, Large
121	Beans, Lima, Colored, Small
122	Beans, Lima, White, Large
123	Beans, Lima, White, Small
124	Beans, Navy
125	Beans, Pink
126	Beans, Pinto
127	Beans, Pinto-red
128	Beans, Red
129	Beans, Red Eye
130	Beans, Red on Black
131	Beans, Red on White
132	Beans, White
133	Beans, Yellow Eye
134	Black Amber Cane
135	Black Amber Cane Seed
136	Broom Corn Seed
137	Buckwheat
138	Any other Grass Seed, named
139	Any other Legume Seed, named
140	Millet
141	Oats, Red
142	Oats, White
143	Peanuts, any variety
144	Peas, Blackeyed
145	Peas, Crowder, dry
146	Peas, Garbanzo
147	Proso Seed
148	Soybeans
149	Sudan Seed
150	Sunflower Head, 7" stem
151	Sunflower seed
152	Sweet Clover Seed
153	Wheat, Hard
154	Wheat, Soft
155	White Clover Seed

Sheaves, Stalks, Heads, Bales (Sheaves must be 3" at butt - 5 stalks or heads)

Class	Description
156	Alfalfa Bale (1 bale)
157	Alfalfa Sheaf
158	Alfalfa Sheaf Seed
159	Amaranth Head (5 heads)
160	Barley Sheaf
161	Black Amber Cane Stalks
162	Blue Gamma Grass Sheaf
163	Brome Grass Sheaf
164	Broom Corn Stalks
165	Clover, Sweet Red
166	Clover, Sweet White
167	Clover, Sweet Yellow
168	Corn Silage Stalks, Indian
169	Corn Silage Stalks, White
170	Corn Silage Stalks, Yellow
171	Hops Cut Loose Quart
172	Millet
173	Oat Sheaf, Grain
174	Oat Sheaf, Hay
175	Grain Head, Proso
176	Rye Sheaf
177	Rye Grass Sheaf
178	Sandrop Seed Grass
179	Sideoats Grama Sheaf
180	Sorghum Grain Heads
181	Sorghum Grain Stalks
182	Sorghum Silage Stalks
183	Sudan Grass Sheaf
184	Wheat Sheaf
185	Crested Wheatgrass Sheaf
186	Intermediate Wheatgrass Sheaf
187	Western Wheatgrass Sheaf
188	Grass, any other sheaf (named)
189	Stalks, any other
190	Heads, any other
191	Any other Bale (1 bale)

Vegetable or Truck Crops

Furnish exact amount specified for each item. Pumpkins, squash and tomatoes must have stems.

Class	Description
192	Arugula/Roquet, 1 bunch
193	Asparagus, Green, 6 stalks
194	Beans, Fresh Shell, Black Eye, 1 quart, in pod
195	Beans, Bush Green, 1 quart
196	Beans, Fava (Lima family), 1 quart
197	Beans, French Felet, 1 quart
198	Beans, French, Horticultural Type, 1 quart
199	Beans, Green (in pod), 1 quart
200	Beans, Green, Pole, 1 quart
201	Beans, Fresh Shell, Lima, 1 quart, in pod
202	Beans, Fresh Shell, Pinto, 1 quart, in pod
203	Beans, Purple Pod (bush), 1 quart
204	Beans, Purple Pod (pole), 1 quart
205	Beans, Romano or Flat Stringless (pole), 1 quart
206	Beans, Romano or Flat (bush), 1 quart
207	Beans, Fresh Shell, Soy, 1 quart, in pod
208	Beans, Yellow Bush, 1 quart
209	Beans, Pole Yellow, 1 quart
210	Beans, Fresh Shell, any other variety named, 1 quart, in pod

211 Beans, any other variety, named, 1 quart	272 Corn, Extra Sweet Roasting, Yellow, 3 ears w/husks
212 Bean, Longest, Edible variety, 1 bean	273 Corn, Sweet Roasting Bi-color, 3 ears w/ husks
213 Beets, Cylindrol (1"-2" trimmed tops), 5 beets	274 Corn, Sweet White Roasting, 3 ears w/ husks
214 Beets, Pickling, Golden (1"-2" trimmed tops), 5 beets	275 Corn, Sweet Yellow Roasting, 3 ears w/ husks
215 Beets, Stock Golden (1"-2" trimmed) 5 beets	276 Corn, any other variety named, 3 ears w/ husks
216 Beets, Table, Golden (1"-2" trimmed tops), 5 beets	277 Cucumbers, Armenian, 3 cucumbers
217 Beets, Pickling, Italian (1"-2" trimmed) 5 beets	278 Cucumbers, Green Burpless, 3 cucumbers
218 Beets, Stock, Italian (1"-2" trimmed), 5 beets	279 Cucumbers, Japanese or White, slicing, 3 cucumbers
219 Beets, Table, Italian (1"-2" trimmed), 5 beets	280 Cucumbers, Lemon, 3 cucumbers
220 Beets, Pickling, Red (1"-2" trimmed tops), 5 beets	281 Cucumbers, Mexican Sour Gherkins, 6 cucumbers
221 Beets, Stock, Red (1"-2" trimmed), 5 beets	282 Cucumbers, Pickling, 5 cucumbers
222 Beets, Table, Red (1"-2" trimmed), 5 beets	283 Cucumbers, Slicing, 3 cucumbers
223 Beets, Pickling, White (1"-2" trimmed), 5 beets	284 Cucumbers, any other, named, 3 each
224 Beets, Stock, White (1"-2" trimmed tops), 5 beets	285 Eggplant, Dark Purple, 1 fruit
225 Beets, Table, White (1"-2" trimmed), 5 beets	286 Eggplant, Green and White Thai, 3 fruits
226 Beets, any other variety named, 5, with trimmed tops	287 Eggplant, Ichiban, 1 fruit
227 Broccoli, Green, 3" butt, bunch	288 Eggplant, Japanese, 1 fruit
228 Broccoli, Purple, 3" butt, bunch	289 Eggplant, miniature, black, 3 fruit
229 Brussel Sprouts, Green, 1 quart	290 Eggplant, miniature, red, 3 fruits
230 Brussel Sprouts, Red, 1 quart	291 Eggplant, miniature, variegated, 3 fruits
231 Cabbage, Celery or Michihili, 1 head	292 Eggplant, White Egg, 1 fruits
232 Cabbage, Chinese, Loose Head, 1 head	293 Eggplant, White, Japanese type, 1 fruit
233 Cabbage, Chinese, Rosette, 1 head	294 Eggplant, any other variety named, 1 fruit
234 Cabbage, Flat, Green, 1 head	295 Endive, 1 bunch
235 Cabbage, Round, Green, 1 head	296 Fennel bulb, 3 bulbs, 1"-2" trimmed tops
236 Cabbage, Napa, Green, any shape, 1 head	297 Garlic, Elephant Dry (no tops), 3 bulbs
237 Cabbage, Napa, Red, any shape, 1 head	298 Garlic, Purple, 3 bulbs, dry (no tops)
238 Cabbage, Pointed, 1 head	299 Garlic, Red Dry (no tops), 3 bulbs
239 Cabbage, Pointed, Green, 1 head	300 Garlic, White Dry (no tops), 3 bulbs
240 Cabbage, Pointed, Red, 1 head	301 Garlic, any other variety named, (no tops) 3 bulbs
241 Cabbage, Flat, Red, 1 head	302 Garlic Rope, any variety, 12" minimum
242 Cabbage, Round, Red, 1 head	303 Greens, any other named "cooking" 2-3" bunch
243 Cabbage, Savoy, green, 1 head	304 Greens, any other named "fresh" 2-3" bunch
244 Cabbage, Savoy, red, 1 head	305 Greens, any other named "oriental" 2-3" bunch
245 Cabbage, Largest, 1 head	306 Greens, Salad, any other variety named, 1 bunch
246 Carrots, Amsterdam/Baby Nantes, (1"-2" trimmed tops) 5 carrots	307 Horseradish, 3 crowns
247 Carrots, Chantenay (1"-2" trimmed tops), 5 carrots	308 Husk Cherries, 10 each
248 Carrots, Danvers (1/2" long, 1-2" trimmed tops), 5 carrots	309 Jerusalem Artichoke, 5 bulbs
249 Carrots, Dark Purple (1"-2" trimmed tops), 5 carrots	310 Kale, 1 bunch, 2"-3"
250 Carrots, Imperator (1"-2" trimmed tops), 5 carrots	311 Kale (Red), 1 bunch, 2"-3"
251 Carrots, Nantes (1"-2" trimmed tops), 5 carrots	312 Kohlrabi, Gigantic (1"-2" trimmed top), 1
252 Carrots, Oxhart (1"-2" trimmed tops), 5 carrots	313 Kohlrabi, Green (1"-2" trimmed tops), 3
253 Carrots, Rainbow, (1"-2" trimmed tops) 5 carrots	314 Kohlrabi, Red (1"-2" trimmed tops), 3
254 Carrots, Round/Nugget (1"-2" trimmed tops), 5 carrots	315 Kohlrabi, White (1-2" trimmed tops,) 3
255 Carrots, White (1"-2" trimmed tops), 5 carrots	316 Leeks (with tops), 3 bulbs
256 Carrots, Yellow (1"-2" trimmed tops), 5 carrots	317 Lettuce Leaf, Green, 1 bunch
257 Carrots, any other type, named (1"-2" trimmed tops), 5 carrots	318 Lettuce Leaf, Red, 1 bunch
258 Cauliflower, Green, 1 head	319 Lettuce, Boston, 1 head
259 Cauliflower, Orange (Cheddar), 1 head	320 Lettuce, Boston Red, 1 head
260 Cauliflower, Purple, 1 head	321 Lettuce, Butter Head, 1 head
261 Cauliflower, Romanasco, 1 head	322 Lettuce, Butter Head, Red, 1 head
262 Cauliflower, White, 1 head	323 Lettuce, Green, 1 head
263 Celeric, 1 plant	324 Lettuce, Oak Leaf, Green, 1 bunch
264 Celery, 1 plant	325 Lettuce, Oak Leaf, Red, 1 bunch
265 Chard, Green, 2-3" bunch	326 Lettuce, Red, 1 head
266 Chard, Rainbow, 2-3" bunch	327 Lettuce, Red Romaine, 1 head
267 Chard, Red, 2-3" bunch	328 Lettuce, Romaine, 1 head
268 Chard, any other variety, named, 2-3" bunch	329 Lettuce, any other variety, named, 1 head
269 Collard Greens, 2-3" bunch	330 Muskmelon, Cantaloupe, 1 melon
270 Corn, Extra Sweet Roasting, Bi-color, 3 ears w/husks	331 Muskmelon, Casaba, 1 melon
271 Corn, Extra Sweet Roasting, White, 3 ears w/ husks	332 Muskmelon, Crenshaw, 1 melon
	333 Muskmelon, Honeydew, 1 melon
	334 Muskmelon, any other long, named, 1 melon
	335 Muskmelon, any other round, named, 1 melon
	336 Mustard Greens, Green, 1 bunch

- 337 Mustard Greens, Red, 1 bunch
 338 Mustard Greens, any other variety named, 1 bunch
 339 Okra, Green, Long, 6 pods
 340 Okra, Green, Short, 6 pods
 341 Okra, Red, 6 pods
 342 Onions, Braid of 5 or more bulbs
 343 Onions, Dry, Pearl, 5 bulbs
 344 Onions, Dry, Red, 5 bulbs
 345 Onions, Table, Red (with tops), bunch, 5 bulbs
 346 Onions, Dry, White, 5 bulbs
 347 Onions, Table, White (with tops), bunch, 5 bulbs
 348 Onions, Dry, Yellow, 5 bulbs
 349 Onions, any other named, 5 bulbs
 350 Pak Choy, 1 plant
 351 Pak Choy, Baby, 1 plant
 352 Pak Choy, any other variety names, 1 plant
 353 Parsnips, top trimmed to 1"-2", 5 parsnips
 354 Peas, Blackeyed, Green, 1 quart
 355 Peas, Chick (Garbanzo), 1 quart
 356 Peas, Crowder, Green, 1 quart
 357 Peas, edible pods, 1 quart
 358 Peas, Garden, 1 quart
 359 Peas, Purple Pod, 1 quart
 360 Peas, Snap, 1 quart
 361 Peppers, Aleppo, 5 peppers
 362 Peppers, Banana, Yellow, 3 peppers
 363 Peppers, Biquinho Red, 3 peppers
 364 Peppers, Biquinho Yellow, 3 peppers
 365 Peppers, Bishop Crown (Mad Hatter), 3 peppers
 366 Peppers, Cayenne, orange, 5 peppers
 367 Peppers, Cayenne, purple, 5 peppers
 368 Peppers, Cayenne, red, 5 peppers
 369 Peppers, Cayenne, yellow, 5 peppers
 370 Peppers, Cherry, 5 peppers
 371 Peppers, Cubanelle, any color, 3 peppers
 372 Peppers, Floral Gem, 3 peppers
 373 Peppers, Guero, yellow or red, 5 peppers
 374 Peppers, Gypsy, 3 peppers
 375 Peppers, Habanero, 5 peppers
 376 Peppers, Hungarian, 3 peppers
 377 Peppers, Jalapeno, green, 5 peppers
 378 Peppers, Jalapeno, red, 5 peppers
 379 Peppers, Jalapeno, yellow, 5 peppers
 380 Peppers, Lunch Box, 3 peppers
 381 Peppers, Mini Sweet Bell, any color or combo, 3 peppers
 382 Peppers, Pimento, Sweet Red, 3 peppers
 383 Peppers, Poblano, 3 peppers
 384 Peppers, Serrano, 5 peppers
 385 Peppers, Shishito, any color, 3 peppers
 386 Peppers, Super Hot Red, 5 peppers
 387 Peppers, Sweet Chocolate Bell, 3 peppers
 388 Peppers, Sweet Green Bell, 3 peppers
 389 Peppers, Sweet Purple Bell, 3 peppers
 390 Peppers, Sweet Red Bell, 3 peppers
 391 Peppers, Sweet Yellow Bell, 3 peppers
 392 Peppers, Thai, 5 peppers
 393 Peppers, White Bell, 3 peppers
 394 Peppers, Long Green, 3 peppers
 395 Peppers, Long Red, 3 peppers
 396 Peppers, Long Named Variety, 3 peppers
 397 Peppers, String Green, 2' long minimum
 398 Peppers, String Red, 2' long minimum
 399 Any other string, 3' long minimum
 400 Peppers, any other green variety, named, 3 peppers
 401 Peppers, any other red variety, named, 3 peppers
 402 Peppers, any other yellow variety, named, 3
 403 Potatoes, Blue, 5 potatoes
 404 Potatoes, any other finger type, named, 5 potatoes
 405 Potatoes, Katahdin, 5 potatoes
 406 Potatoes, Kenebec, 5 potatoes
 407 Potatoes, Lasorta, 5 potatoes
 408 Potatoes, Norgold, 5 potatoes
 409 Potatoes, Norland Red, 5 potatoes
 410 Potatoes, Onoway, 5 potatoes
 411 Potatoes, Pontiac, 5 potatoes
 412 Potatoes, Purple, 5 potatoes
 413 Potatoes, Red Dale, 5 potatoes
 414 Potatoes, any other red, name variety, 5 potatoes
 415 Potatoes, Russet, 5 potatoes
 416 Potatoes, Russian Banana, 5 potatoes
 417 Potatoes, Sweet, any variety, named, 3 potatoes
 418 Potatoes, White Rose, 5 potatoes
 419 Potatoes, any other white, name variety, 5 potatoes
 420 Potatoes, Yellow Finn, 5 potatoes
 421 Potatoes, Yellow Lady Fingers, 5 potatoes
 422 Potatoes, Yukon Gold, 5 potatoes
 423 Potato, Largest, any variety, 1 potato
 424 Potatoes, any other variety, named, 5 potatoes
 425 Pumpkin, Bush (with stem), 1 pumpkin
 426 Pumpkin, Field (with stem), 1 pumpkin
 427 Pumpkin, Miniature Orange (with stem), 1 pumpkin
 428 Pumpkin, Miniature White (with stem), 1 pumpkin
 429 Pumpkin, Miniature Yellow (with stem), 1 pumpkin
 430 Pumpkin, Pie (with stem), 1 pumpkin
 431 Pumpkin, Largest (with stem), 1 pumpkin
 432 Pumpkin, any other variety, named, 1 pumpkin
 433 Raddicio, 1 bunch or head
 434 Radish, Bi-color, Long (1" tops), 6 radishes
 435 Radish, B -color, Round (1" tops), 6 radishes
 436 Radish, Black, long (1"-2" trimmed tops) 3 radishes
 437 Radish, Black, round (1"-2" trimmed tops), 3 radishes
 438 Radish, Daikon (1"-2" trimmed top), 1 radish
 439 Radish, purple (1"-2" trimmed tops), 6 radishes
 440 Radish, Red, long (1"-2" trimmed tops), 6 radishes
 441 Radish, Red, round (1"-2" trimmed tops), 6 radishes
 442 Radish, White, long (1"-2" trimmed tops), 6 radishes
 443 Radish, Largest, 1 radish
 444 Radish, any other, named, 1-2" trimmed tops, 6 radishes
 445 Rhubarb, Green, 6 stalks with part of leaf
 446 Rhubarb, Red, 6 stalks with part of leaf
 447 Rutabaga (1"-2" trimmed tops), 5
 448 Salsify, with tops, 3 plants
 449 Shallots, Dry, 6 bulbs
 450 Shallots, Green (with tops), bunch, 6 bulbs
 451 Spinach, 1 bunch, 1" butt
 452 Spinach, Savoy, 1 bunch, 1" butt
 453 Spinach, any other variety, 1 bunch, named, 1" butt
 454 Squash, Acorn (table queen), 1 squash
 455 Squash, Acorn, gold, 1 squash
 456 Squash, Acorn, variegated, 1 squash
 457 Squash, Acorn, white, 1 squash
 458 Squash, Banana, blue, 1 squash
 459 Squash, Banana, pink, 1 squash
 460 Squash, Banana, yellow, 1 squash
 461 Squash, Blue Hubbard, 1 squash
 462 Squash, Buttercup, (turban), 1 squash
 463 Squash, Butternut, 1 squash
 464 Squash, Cashaw Crookneck, 1 Squash

- 465 Squash, Cashaw Mexican, 1 squash
 466 Squash, Summer, Cocozelle, 3 squash
 467 Squash, Gold Nugget, 1 squash
 468 Squash, Summer, Gold Scallop, 3squash
 469 Squash, Golden Hubbard, 1 squash
 470 Squash, Summer, Gourmet Globe, 3 squash
 471 Squash, Green Hubbard, 1 squash
 472 Squash, Summer, Green Scallop, 3 squash
 473 Squash, Summer, Greyzini, 3 squash
 474 Squash, Summer, Kuta, 3 squash
 475 Squash, Summer, Marrow White, 3 squash
 476 Squash, Summer, Scallopini, 3 squash
 477 Squash, Spaghetti, 1 squash
 478 Squash, Summer, Sundrop, 3 squash
 479 Squash, Sweet Dumpling, 1 squash
 480 Squash, Sweet Mama, 1 squash
 481 Squash, Summer, White Scallop, (patty pan), 3 squash
 482 Squash, Summer, Yellow Crookneck, 3 squash
 483 Squash, Summer, Yellow Scallop, 3 squash
 484 Squash, Yellow Straight neck, 3 squash
 485 Squash, Summer, Yellow Straight neck, Zephar, 3 squash
 486 Squash, Summer, Zucchini, Black, 3 squash
 487 Squash, Summer, Zucchini, Golden, 3 squash
 488 Squash, Summer, Zucchini, green 3 squash
 489 Squash, Zucchini, Largest, 1 squash
 490 Squash, Summer, Zucchini, Round, 3 squash
 491 Squash, Summer, Zucchini, Round Green, 3 squash
 492 Squash, Summer, Zucchini, Round Yellow, 3 squash
 493 Squash, Summer, Zucchini, Round, White, 3 squash
 494 Squash, Summer, Zucchini, White, 3 squash
 495 Squash, Summer, any other variety, named, 3 squash
 496 Squash, Winter, Largest, 1 squash
 497 Squash, Winter, any other variety, named, 1 squash
 498 Tomato, Black Cherry (with stems), 10 tomatoes
 499 Tomato, Black Medium Fruited (with stems), 5 tomatoes
 500 Tomato, Black Slicer (with stems), 5 tomatoes
 501 Tomato, Green (with stems), 5 tomatoes
 502 Tomato, Green Cherry (with stems), 10 tomatoes
 503 Tomato, Green Paste (with stems), 5 tomatoes
 504 Tomato, Red, ripe, 5 tomatoes (with stems)
 505 Tomato, Red Cherry (with stems), 10 tomatoes
 506 Tomato, Red Paste (with stems), 5 tomatoes
 507 Tomato, Red Pear, (with stems) 10 tomatoes
 508 Tomatillo Green, 5 tomatillos
 509 Tomatillo, Purple, 5 tomatillos
 510 Tomato, Yellow, ripe, 5 tomatoes (with stems)
 511 Tomato, Yellow Cherry (with stems), 10 tomatoes
 512 Tomato, Yellow Pear (with stems), 10 tomatoes
 513 Tomato, Yellow Plum (with stems), 10 tomatoes
 514 Tomato, Largest, 1 tomato
 515 Tomato Clusters, small fruit tomatoes on 1 stem, 5 or more, not cherry tomatoes
 516 Tomato Clusters, medium fruit tomatoes on 1 stem, 5 or more
 517 Tomato, any other small fruited variety, named, ripe, 10 tomatoes (with stems)
 518 Tomato, any other medium fruited variety, named, ripe, 5 tomatoes (with stems)
 519 Tomato, any other large fruited variety, named, ripe, tomatoes (with stems)
 520 Tomato, any other paste variety, named, ripe, 5 tomatoes (with stems)

- 521 Tomato, any other color variety, named, ripe, 5 tomatoes (with stems)
 522 Turnips, Oriental, tops trimmed to 1-2", 3 turnips
 523 Turnip, Largest, tops trimmed to 1-2", 1
 524 Turnips, any variety, named, tops trimmed to 1-2", 3 turnips
 525 Watermelon, Gold, 1 melon
 526 Watermelon, Midget Ripe, 1 melon
 527 Watermelon, Red, any variety, ripe, 1 melon
 528 Watermelon, Yellow, any variety, ripe, 1 melon
 529 Watermelon, Largest, ripe, 1 melon
 530 Watermelon, any variety, named, ripe, 1 melon
 531 Any other Vegetable, named

Garden Collection

Class Description

- 532 Garden Collection: any 5 classes (excluding eggs and honey). Display amounts specified in those classes.

Fruits

All exhibits must be free of disease and insect damage.

Exhibitor must specify variety at time of entry. The Superintendent will not accept responsibility for classification as to variety or class.

Apples (5 to a plate, unless noted otherwise)

Class Description

- 533 Arkansas Black Apples
 534 Bellflower
 535 Ben David Apples
 536 Crab Apples, Red (10 apples)
 537 Crab Apples, Golden (10 apples)
 538 Delicious, Double Red Apples
 539 Delicious, Golden Apples
 540 Delicious, Old Style Apples
 541 Delicious, Stark Crimson
 542 Gravenstein
 543 Grimes, Golden Apples
 544 Jonalicious
 545 Jonathan Apples
 546 MacIntosh
 547 Maiden Blush
 548 Red Jonathan
 549 Red June
 550 Red Rome Beauty
 551 Rome Beauty
 552 White Winter Permain
 553 Winesap, Double Red
 554 Winesap, Golden
 555 Winesap, Old Fashioned
 556 Winesap, Stayman
 557 Any other variety apple, named

Pears (5 to a plate)

Class Description

- 558 Bartlett Pears
 559 D'Anjou Pears
 560 Keifer Pears
 561 Lincoln Pears
 562 Winter Bartlett Pears
 563 Winter Nelis Pears
 564 Any other variety pears, named

Peaches (5 to a plate)

Class	Description
565	Early Elberta Peaches
566	Freestone Peaches
567	Halberta Peaches
568	J. H. Hale Peaches
569	Late Elberta Peaches
570	Red Haven Peaches
571	Any White Clingstone
572	Any White Freestone
573	Any Yellow Clingstone
574	Any other peach, named

Pomegranate (3 to a plate)

Class	Description
575	Dwarf Pomegranate
576	Large Red Pomegranate

Nectarines (5 to a plate)

Class	Description
577	Nectarines, any variety, named

Figs (1 quart)

Class	Description
578	Figs, any variety, named

Plums (1 quart)

Class	Description
579	Damson, Improved Plums
580	Damson, Old Fashioned Plums
581	Delicious Plums
582	Elephant Heart Plums
583	Prune Plums
584	Santa Rosa Plums
585	Any other variety plums, named

Berries (1/2 pint on plate or boat)

Class	Description
586	Blackberries
587	Boysenberries
588	Currants
589	Gooseberries
590	Raspberries
591	Strawberries
592	Any other variety berries, named

Grapes (3 to 6 bunches to a plate)

Class	Description
593	Beta
594	Cardinal Grapes
595	Concord Purple
596	Concord White
597	Delaware
598	Muscat, dry (raisins)
599	Perlette
600	Purple, seedless
601	Red, seedless
602	Thompson Seedless
603	Thompson Seedless (raisins), 1 pint
604	Tokay
605	Any other variety, White Seedless, named

Other Fruit

606	Any other fruit, named
-----	------------------------

Herbs – Dry (1/4 pint)

Class	Description
607	Anise Hyssop, Dry
608	Anise, Dry
609	Balm, Lemon, Dry
610	Basil, Dry
611	Borage, Dry
612	Catnip, Dry
613	Chamomile, Dry
614	Chives, Dry
615	Coriander, Dry
616	Dill, Heads or 1/4 pint seed, Dry
617	Dill, Leaves, Dry
618	Elderberry, Dry
619	Fennel head or 1/4 pt. seed
620	Fennel, weed Dry
621	Horehound, Dry
622	Lavender, Dry (1/2 cup bloom head)
623	Lovage, Dry
624	Marjoram, Dry
625	Mint, Dry
626	Oregano, Dry
627	Parsley, Dry
628	Raspberry, Dry
629	Rosemary, Dry
630	Sage, Dry
631	Savory, Dry
632	Strawberry, Dry
633	Tarragon, Dry
634	Thyme, Dry
635	Any other, named

Herbs - Fresh (1/2"-1" bunch)

Class	Description
636	Anise, fresh herbs
637	Balm, Lemon, fresh herbs
638	Basil, Cinnamon, fresh herbs
639	Basil, Dark Opal, fresh herbs
640	Basil, Lemon, fresh herbs
641	Basil, Lettuce, fresh herbs
642	Basil, Licorice, fresh herbs
643	Basil, Mini Leaf, fresh herbs
644	Basil, Ruffled, fresh herbs
645	Basil, Sweet, fresh herbs
646	Basil, Thai, fresh herbs
647	Borage, fresh herbs
648	Caraway, fresh herbs
649	Catnip, fresh herbs
650	Chamomile, fresh herbs
651	Chervil, fresh herbs
652	Cilantro, fresh herbs
653	Comfrey, fresh herbs
654	Coriander, fresh herbs
655	Costmary, fresh herbs
656	Dill, Leaf, fresh herbs, 3 seed double heads
657	Dill, Seed Head, fresh herbs, 3 seed double heads
658	Fennel, fresh herbs, 3 seed double heads
659	Garlic Chives Tops, fresh herbs, Greens only
660	Garlic Chives Tops, fresh herbs, Garlic blossom tops only
661	Lavender, fresh herbs

662	Lemongrass, fresh herbs
663	Lovage, fresh herbs
664	Marjoram, fresh herbs
665	Marjoram, Golden, fresh herbs
666	Mint, Any other fresh variety
667	Mint, Apple, fresh herbs
668	Mint, Chocolate, fresh herbs
669	Mint, Pineapple, fresh herbs
670	Oregano, fresh herbs
671	Parsley, Curley, fresh herbs
672	Parsley, Single Leaf, fresh herbs
673	Peppermint, fresh herbs
674	Regular Chives Tops, fresh herbs
675	Rosemary, fresh herbs
676	Rue, fresh herbs
677	Sage, fresh herbs
678	Sage, Pineapple, fresh herbs
679	Savory, fresh herbs
680	Spearmint, fresh herbs
681	Stevia, fresh herbs
682	Tarragon, fresh herbs
683	Thyme, fresh herbs
684	Thyme, Lemon, fresh herbs
685	Winter Savory, fresh herbs
686	Any other Fresh Herbs

Hot House (same quantity as open class)

Class	Description
687	Cucumbers, hot house
688	Eggplant, hot house
689	Greens, hot house
690	Peppers, Chili, hot house
691	Peppers, Green, hot house
692	Peppers, Red, hot house
693	Peppers, Yellow, hot house
694	Tomato, Cherry, Red, hot house
695	Tomato, Cherry, Yellow, hot house
696	Tomato, Green, hot house
697	Tomato, Red, hot house
698	Any other Hot House item

Hydroponic (same quantity as open class)

Class	Description
699	Basil, hydroponic
700	Cucumber, hydroponic
701	Eggplant, hydroponic
702	Lettuce, bunch, hydroponic
703	Lettuce, head, hydroponic
704	Peppers, large, hydroponic
705	Peppers, small, hydroponic
706	Tomatoes, hydroponic
707	Hydroponic, any other variety

Nuts (1 Quart)

Class	Description
708	Almonds
709	Pecans
710	Walnuts, English
711	Walnuts, Native Black
712	Nuts, any other

Freak fruit or vegetable

Class	Description
713	Any Freak Fruit
714	Any Freak Vegetable

Educational Display

Call superintendents for size limitations.

Class	Description
715	Ed Display, Water Conservation
716	Ed Display, New ideas or Garden Products
717	Ed Display, Any Other

Eggs (1/2 dozen, cut regular cartons to size for exhibition)A diet scale may be used to determine weight.

Small:	1.5-1.75 oz.
Medium:	1.75-2 oz.
Large:	2-2.25 oz.
Extra Large:	2.25-2.5 oz.
Jumbo:	Over 2.5 oz.

Class	Description
718	Eggs, Brown, Small
719	Eggs, Brown, Medium
720	Eggs, Brown, Large
721	Eggs, Brown, Extra Large
722	Eggs, Brown, Jumbo
723	Eggs, Color
734	Eggs, White, Small
725	Eggs, White, Medium
726	Eggs, White, Large
727	Eggs, White, Extra Large
728	Eggs, White, Jumbo
729	Eggs, Single largest
730	Eggs, Duck, Small
731	Eggs, Duck, Medium
732	Eggs, Duck, Large
733	Eggs, Emu
734	Eggs, Goose
735	Eggs, Ostrich
736	Eggs, any other
737	Eggs, Freak

Apiary

NOTE: Because of excellent quality entries, we have changed the rules so that entries will be eligible to exhibit at the Arizona State Fair. Apiary Exhibitors shall comply with the following rules:

1. Exhibitor must be a resident of Coconino County.
2. All exhibits must be in shape to place on display when brought to the Department. All necessary pre-exhibit preparation must be completed before being brought to the department. Exhibitors may use their own labels or affix their name and Class number to the bottom of the jar or package. However, for the purpose of judging, one jar or package in each Class must have no other label than the identification tag.
3. All containers must be clean and of uniform size and shall comply with regulations as to size.
4. All combs must be new combs wrapped in heavy cellophane or be in a single frame observation hive.
5. All entries to be produced after August of prior year.

**Extracted Honey
(3 glass jars, 1 pound each)**

Class	Description
738	Honey, Citrus
739	Honey, Clover
740	Honey, Mesquite
741	Honey, Sunflower
742	Honey, light colored, other
743	Honey, medium colored, other
744	Honey, dark colored, other
745	Honey, Chunk comb-in
746	Honey, Granulated (candied)
747	Honey, Cut comb
748	Honey, New comb, finished sealed
749	Beeswax, Candles dipped, 2 pair
750	Beeswax, Candles molded, 2 pair
751	Beeswax, Carved
752	Beeswax, Molded
753	Pollen, Bee
754	Any other Apiary product

Scorecard For Judging Honey

Extracted Honey	Score
Clearness	25%
Body	25%
Color	25%
Flavor	25%
Comb Honey	Score
Cappings	25%
Fullness	25%
Cleanliness	25%
Color	25%

Scorecard For Judging Beeswax

Beeswax	Score
Attractiveness of Display	10%
Color	40%
Cleanliness	50%

Special Thanks to Our 2022 Sponsors!

Mike & Sarah Cromer
Friends of Coconino County Parks

Thank you 2022 Volunteers!

Abigail Stimmel
Brynn Merz
Elizabeth Baldwin
Jean Nagurney
Kami Ahn
M Angel Ramirez
Myrna Rodriguez Carter
Ron Hiebert
Russell Mann
Sara Sprauge
Sharon Pacheco
Steve Lipinski



**Volunteers Needed
for the Coconino County Fair!**

Like it takes a village to raise a child, it also takes a village to put on the Coconino County Fair. There are numerous opportunities to be a part of the County Fair and we hope you will join us. Volunteers, 16 years or older, are needed in the following areas:

- Help decorate and clean buildings during Fair Work Day
- Help on receiving days
- Support preparing buildings for judging
- Assist on judging day
- Help at the Information Booth
- Help at the Volunteer Booth
- Volunteer at the Recycling Booth
- Outreach support
- Be a judge in your area of expertise
- Be a building sitter during the Fair
- Help with entry removal at conclusion of the Fair
- Be a building superintendent

For every four hours of volunteer time given to the fair, volunteers will receive two complimentary fair admissions with parking, good for any one-day of the Fair, and a volunteer thank you bag.

A maximum of six admission passes may be earned per person.

Interested volunteers should call (928) 679-8000 or email fair@coconino.az.gov with availability.

Fine Arts

Department Code "FA"



Nancy Reniker-Neve, Superintendent
(928) 351-7822, CCF.FineArts@gmail.com



Dorene Washington, Superintendent
(928) 362-1857, billionairebeauty29@gmail.com

Entry Fee: \$0.00 / entry

Entry Forms Due: Saturday, August 5

**Receiving Dates: Friday, August 18, 6 - 8 p.m. and
Saturday, August 19, 1 - 6 p.m.**

Release Date: September 4, 4 - 6 p.m.

Department Rules

1. All General Fair Rules apply.
2. Eligibility: Open to artists and photographers who are permanent residents of Coconino County. Youth not yet in High School are to enter in the Open Youth Department.
3. Entry Limit: You may enter FIVE total entries per person. Every item is counted as an entry item.
4. Entry Forms: All entries must have a title. If it is for sale, list the price, if not for sale put (NFS). Must include the Department Code (Fine Arts 'FA'), Division code (High School (HS) or Adult (A)), Class number, and description category.
5. Entries:
 - a. All work must be original and created by the exhibitor, and must not have been exhibited at any previous Coconino County Fair.
 - b. Do not put your name on the back of each work. Do not put your name on the front of the work. Fine Arts staff will put a piece of tape over the name.
 - c. Entries will receive careful handling and supervision throughout the Fair, however, insurance on your exhibit, if desired, must be carried by the artist. Coconino County Parks and Recreation will not be responsible for lost, stolen, or damaged items.
 - d. As long as space allows, all entries will be displayed. Entries found offensive in any way will not be exhibited. The Fair is a family event. The Department

Superintendents will make the decision.

6. Community Purchases: Mark the sale price clearly on the entry tag. An interested buyer will be asked to leave their name and phone number with the building host so that the seller may contact them. There is no fee for sale of work, but items may not be removed before the release time.
7. Awards: See the general rules in the front of this book for information on receiving awards, In addition, various merchants and groups may donate awards.
8. Release of Exhibits: Artists whose work is not accepted will be notified to pick up their work prior to the opening of the Fair. Exhibits will be released between 4 p.m. and 6 p.m. on the last day of the Fair. Please remember to bring your claim tickets. Any items not picked up within 5 business days of the last day of the Fair will be donated to a local charity.
9. Judging: Work will be judged in the American System and will be evaluated based on originality, interest, composition, technique, and presentation. If there are only a few items in a class, those items may be combined with similar classes for judging purposes. Results submitted by Judge(s) are considered final.

Judging Criteria

15% Is there a strong subject?

15% Did the photographer use the best light for the subject?

15% Is it good technically? Sharpness, exposure, color)

15% Is there good use of design and composition?

20% Is there a sense of telling a story or conveying an emotion?

20% Effort to capture best possible image under the circumstances?

Division Codes

(HS) - High School: Any person enrolled in High School or home schooled (ID required).

(A) - Adult: Any Adult.

Awards



Sponsored by
**Friends of Coconino
County Parks**

Awards Continued

First, Second, Third, Honorable Mention: Ribbon

People's Choice:

Artwork: \$50

Photography: \$50

Best of Show

Adult Artwork: \$25

Adult Photography: \$25

Youth Artwork: \$25

Youth Photography: \$25

Two Dimensional Art: Each entry must be securely wired to both sides of the entry. Frames are optional. Items will be refused until properly prepared and wired for hanging. Maximum size is 36" x 48".

Three Dimensional Art: Can be displayed in locked display cases with a maximum shelf width of 11". Special stands must be provided by the artist. Call the superintendent for advice on pieces that will not fit in the display cases.

Photography: NO FRAMES. Prints, including cell phone photographs, must be a minimum of 8"x10" up to a maximum of 16"x20", except Panoramic Prints. All entries must be mounted on 16"x20" backing board with a minimum thickness of 1/16" (no construction paper) and a maximum thickness of 5/16" regardless of print size. Photos are displayed in mounting brackets that are affixed to the wall. Plexiglass (provided by the Fair) will be placed over the photo. Landscape or Portrait orientation are accepted.

For additional video examples of entry requirements visit coconinocountyfair.com.

Paintings

Exhibitors may enter a maximum of five entries in the Fine Arts Department.

Oils

Class Description

- 100 Any painting in which an animal(s) is the center of interest
- 101 Any painting in which a man-made object(s) is the center of interest
- 102 Any painting in which a person(s) is the center of interest
- 103 Any painting of a landscape, seascape, etc.
- 104 Any painting in which Flowers, Fruit, etc. is the center of interest.
- 105 Any painting which does not fit into one of the categories listed above.

Water Media

Acrylic Washes

Includes watercolor, dyes, gouache, opaque, transparent color, aquella, tempera, etc.

Class Description

- 106 Any water media as defined above in which an animal(s) are the center of interest.
- 107 Any water media as defined above in which a man-

made object(s) is the center of interest.

- 108 Any water media as defined above in which people are the center of interest
- 109 Any water media as defined above of a landscape, seascape, etc.
- 110 Any water media as defined above of flowers, fruit, etc.
- 111 Any water media as defined above which does not fit into one of the categories above.

Acrylics

Class Description

- 112 Any painting in which an animal(s) is the center of interest
- 113 Any painting in which a man-made object(s) is the center of interest
- 114 Any painting in which a person(s) is the center of interest
- 115 Any painting of a landscape, seascape, etc.
- 116 Paintings of flowers, fruit, etc.
- 117 Other, Acrylics

Drawings

Color Drawings

Class Description

- 118 Any medium (pencil, pen, marker, pastels, chalk, etc.)

Black And White Drawings

Includes monochromatic pictures.

Class Description

- 119 Any medium (pencil, pen, marker, pastels, chalk, etc.)

Other Two-Dimensional Pictures

Mixed Media

Class Description

- 120 Any combination of painting, drawing, or other two-dimensional material glued or attached to a surface

Stained Glass

Class Description

- 121 Must be original design

Other Two-Dimensional Art

Class Description

- 122 Any picture that does not fit in the above categories

Three-Dimensional Works

Shelf depth in display cases is 11 inches. Special stands must be provided by the artist.

Class Description

- 123 Blown glass
- 124 Fused glass
- 125 Jewelry
- 126 Artistic pottery
- 127 Utilitarian pottery
- 128 Metal sculpture or objects
- 129 Mixed material sculpture or objects
- 130 Wood sculpture or objects
- 131 Clay sculpture
- 132 Other (objects that do not fit in the above categories)

Photography**Photography – Coconino County Fair**

Any photo of any subject taken during a Coconino County Fair. County Fair staff will select the winner who may be asked for permission to use their photograph for the promotion of future County Fairs. Photographer will be properly acknowledged.

Class	Description
200	Coconino County Fair – Color
201	Coconino County Fair – Black and White
202	Coconino County Fair – Tones
203	Coconino County Fair – Other

Color Photography Nature Close-ups / Macro

Class	Description
204	Close-up, color prints in which nature is the center of interest

Color Photography – Animal

Prints in which an animal(s) is the center of interest.

Class	Description
205	Birds
206	Pets
207	Insects
208	Wildlife
209	Animals in action (no people)

Color Photography – Man-Made Object

Prints in which a man-made object(s) is the center of interest.

Class	Description
210	Buildings, modern
211	Buildings, old
212	Vehicles or transportation theme
213	Other

Color Photography – People

Prints in which a person(s) is the center of interest.

Class	Description
214	Portraits
215	Scenes with people
216	Scenes with people in action

Color Photography – Scenic

Prints of landscape, seascape, etc.

Class	Description
217	Water scenes
218	Sky scenes (not a sunset)
219	Sunset scenes
220	Flagstaff, San Francisco Peaks, Grand Canyon area
221	Southwest US
222	Scenic with silhouette focus
223	Other landscapes

Color Photography – Still Life

Prints of flowers, fruit, etc.

Class	Description
224	Flowers
225	Other

**Color Photography - Other**

Class	Description
226	Prints which do not fit into one of the categories above

Photo Composition

Class	Description
227	Two or more images combined into a single composition using computer software. Final image should appear photographic or a collage/assemblage, not an illusion.

Photo Manipulation

Class	Description
228	A composition created from a photo altered from the original state, using effects such as filters, smudging, cloning, layering, color modification, etc. Includes photo altered to look like paintings. Final composition may appear photographic, abstract or painted.

Photography Cell Phone

Must be taken with a cell phone. Color or black and white is accepted. No selfies accepted.

Class	Description
259	Prints which do not fit into one of the categories above.

Photography Panoramic

Any panoramic print, any subject not to exceed 16 inches high by 40 inches long.

Class	Description
229	Panoramic – Color
230	Panoramic – Black and White
231	Panoramic – Tones

Alternative Medium

Color or black and white is accepted.

Class	Description
260	Open, Any prints, Other medium (not metallic)
261	Lithography

Metallic Medium

Any print utilizing the metallic process, either in the printing process or on metal.

Class	Description
232	All animals (bird, mammals, etc.)
233	Other

Black and White Photography

Includes monochromatic prints only. No tones or colors.

Black and White Metallic

Any print utilizing the metallic process, either in the printing process or on metal.

Class	Description
234	Open

Black and White Photography Nature Close-ups / Macro

Class	Description
(no tones or colors)	

235 Close-up, black and white prints in which nature is the center of interest.

Black and White Photography – Animal

Prints in which an animal(s) is the center of interest.

Class Description

- 236 Birds
- 237 Mammals
- 238 Pets
- 239 Insects
- 240 Wildlife
- 241 Animals in action (no people)

Black and White Photography – Man-Made Object

Prints in which a man-made object(s) is the center of interest.

Class Description

- 242 Buildings, modern
- 243 Buildings, old
- 244 Vehicles or transportation theme
- 245 Other

Black and White Photography – People

Prints in which a person(s) is the center of interest.

Class Description

- 246 Portraits
- 247 Scenes with people
- 248 Scenes with people in action

Black and White Photography – Scenic

Prints of landscape, seascape, etc.

Class Description

- 249 Water scenes
- 250 Sky scenes (not Sunsets)
- 251 Sunset scenes
- 252 Flagstaff, San Francisco Peaks,
- 253 Southwest US scenic
- 254 Scenic with silhouette focus
- 255 Other landscapes

Black and White Photography – Still Life

Prints of flowers, fruit, etc.

Class Description

- 256 Flowers
- 257 Other

Black and White Photography – Other

Class Description

- 258 Prints which do not fit into an above category.

Thanks to Our 2022 Sponsor!

Friends of Coconino County Parks

Thank you 2022 Volunteers!

Anna Whorton	Jennifer Glennon
Antonia Steffey	John Gallegos
Banra Casey	Myrna Rodriguez Carter
Chloe Casey	Nicole Neve
Emmaline Tsosie	Randy McNiff
Faith Brittain	Tanya Scharton
Gregg Pratt	Valerie Connell
Jason Oberman	

Artist Demonstrations

Art demonstrations have proven to be a County Fair favorite so take the spotlight while sharing your artistic talent with fairgoers. Individuals or art organizations are encouraged to request time slots as volunteer Artist Demonstrators.

Demonstrations will take place inside the Fine Arts Department. If interested please contact:

Fine Arts Department
Coconino County Parks and Recreation
2446 Fort Tuthill Loop, Flagstaff, AZ 86005
Phone: 928-679-8000
fair@coconino.az.gov

Demonstration Time Slots:

Friday, September 2, Saturday, September 3, and Sunday, September 4:

10 a.m. – 1 p.m.

1 p.m. – 3 p.m.

3 p.m. – 6 p.m.

6 p.m. – 9 p.m.

Monday, September 5:

10 a.m. – 1 p.m.

1 p.m. – 3 p.m.

Confirmation of date and time of demonstrations will be by August 20. Call 928-679-8000 for details.

Artist Demonstration Criteria:

1. Artists must pre-register no later than August 13, 2023. Confirmation of selection will be made by August 16.
2. Demonstrating artists must be 18 years or older.
3. Demonstrating artists are asked to provide their own art supplies and equipment.
4. Artists may demonstrate in any medium.
5. Art produced during the demonstration may be displayed for the duration of the fair as space allows. Artwork size and type may limit the ability of it being displayed. Artwork left on display must be retrieved between 4 p.m. and 6 p.m., on the last day of the Fair.
6. Artwork left to be displayed will receive careful handling; however, Coconino County Parks and Recreation will not assume responsibility for lost, stolen or damaged items.
7. The County Fair is a family event therefore artwork found to be in any way offensive will not be permitted demonstration or display. The determination of offensive artwork will be made by the Fine Arts Superintendent in consultation with Fair Management. Decisions will be final.
8. Art demonstrations will take place inside the Fine Arts Department unless other arrangements are made and approved by Fair Management.
9. Demonstrating Artists will receive two complimentary fair admissions.
10. Artists may post their artwork for sale. Sold artwork may not be removed from the building without prior approval from the superintendent.

Floriculture

Department Code "FL"



Carol Burris, Superintendent
(928) 526-9021

Entry Fee: \$0.00 / entry

Entry Forms Due: August 18th

Receiving Date: August 31, 2 - 6 p.m.

Release Date: September 4, 4 - 5 p.m.

Department Rules

1. All General Fair Rules apply.
2. All floriculture exhibits must be grown by the exhibitor and must be free of disease and insect infestation. Potted plants must have been grown by the exhibitor for at least six (6) months before entry and not have been a Blue Ribbon winner for the previous two years. The name and address of the owner must be placed on the underside of the container (if possible).
3. The Youth Age Group category is open to Coconino County residents under the age of 18 as of July 31, 2023. Rules and Classes are the same as for adults.
4. Containers will be available for cut specimens, except extra large dahlias and mammoth sunflowers.
5. Any entry not conforming to this schedule may be placed for exhibit but will not be judged. The show committee will not correct entries. If you are unsure of what Class an entry belongs in, please contact the Floriculture Superintendent.
6. All cut garden flower entries become the property of the Fair and will not be returned to the exhibitor.
7. Wild (native) growth that is on the State Conservation List must be accompanied by a permit or a written statement that it was grown on private property.
8. All fresh material must have an ample water supply available to insure good condition throughout the display period. The Floriculture Superintendent reserves the right to remove any exhibit once its appearance becomes unsuitable.
9. The number of entries to be made by one person for competition shall not be limited, however, each exhibitor may have only one entry per Class. Only residents from Coconino County will be eligible for competition.
10. Exhibitors showing five entries will receive one 1-day Fair admission.
11. Judging results submitted by judges and Department Superintendent are considered final.
12. Ribbons will be awarded according to merit. All items are judged against items in the same Class.
13. Entries will be released 4-5 pm the last day of the Fair.

Division Codes

(Y) - Youth (under 18)

(A) - Adult (18 and over)

Note: All youth entries will use the same Class numbers as the adult entries. Please use the Division Code above.

Awards

First: Ribbon, Second: Ribbon, Third: Ribbon

Top Gardener:

Adult: Special Awards

Youth: Special Awards

Best of Show:

Adult: \$25

Youth: \$25

Horticulture: \$25

Potted Plant: \$25

Rose: \$25

Patio Pot: \$25

Collection: \$25

Dahlia: \$25



Sponsored by
**Friends of Coconino
County Parks**

Youth Best:

Horticulture: \$25

Potted Plant: \$25

Rose: \$25

Dahlia: \$25



Sponsored by
The Cromer Family

Special Awards Sponsored by:

Friends of Coconino County Parks

Mike and Sarah Cromer

Northern Light Tree Co. & Landscape Maintenance LLC

Viola's Flower Garden

Warner's Nursery & Landscape Co.

How to Choose and Condition Specimens

1. Material for exhibition should be cut in the very early morning or late evening. Most plant material should be placed in warm deep water in a dark or shaded place away from all drafts, and left for several hours or overnight.
2. A mixture of lemon lime soda (not diet soda) and water (equal parts) will keep cut flowers fresh longer. Let this set ½ hour before adding flowers. Cut flower on a slant with a sharp blade, leaving enough stem to be re-cut again at the time of entry. Where possible, remove foliage from at least half of the length of the stem. At the time of entry, re-cut on a slant at least ½" above the end of stem.
3. If the blossoms must be transported some distance, they should be packed carefully in boxes and the flowers separated and protected with waxed paper. Very delicate blossoms should be carried in an upright position in tall cans or buckets half-filled with cool water. Crushed paper, sphagnum moss, sand or plastic snow may be used around the stems to hold them in place.
4. When selecting horticultural specimens, choose blossoms at the "peak of perfection". They should be uniform in size with stems straight, sturdy, and approximately the same length. Dust or spray residue should be carefully washed away.
5. Roses for exhibition should be cut when buds are one-third to one-half open. Roses, dahlias, poppies and any other flower that "bleeds" should be placed in fairly hot water after cutting.
6. Many specimens may be kept for several days at the "peak of perfection" by wrapping them in waxed paper or plastic, and keeping them in the refrigerator, with stems in water.

GARDEN FLOWERS**Agastache**

Class	Description
100	1 stem
101	3 stems, 1 color
102	3 stems, Different colors
103	Alyssum (Alyssum and Aurinia), 3 stems, 1 color
104	Amaranthus, 1 stem
105	Anchusa (Italica), 1 stem
106	Anthemis, 3 stems

Artemisia

Class	Description
107	Absinthe (Powis Castle), 1 stem
108	Guizo, 1 stem
109	Schmidtiana (Silver Mound), 1 stem
110	Stellerana, 1 stem
111	Any other variety, 1 stem

Aster, Annual (Callistephus Chinensis)

Class	Description
112	Large varieties, 4" and over, 1 stem
113	Small varieties, under 4", 3 stems
114	One variety, as many different colors as possible

Aster, Perennial

Class	Description
115	Alma Potschke, 1 stem
116	1 stem
117	3 stems, one color
118	3 stems, different colors
119	Professor Kippenburg, 1 stem
120	September Ruby, 1 stem
121	As many colors as possible

Astilbe

Class	Description
122	1 stem
123	3 stems, different colors

Baby's Breath (Gypsophila)

Class	Description
124	Single, pink, 1 stem
125	Single, white, 1 stem
126	Double, 1 stem

Bachelor's Button (Centaurea Yanus)

Class	Description
127	3 stems, 1 color
128	3 stems, different colors

Begonia (Bedding, Wax), Annual

Class	Description
129	1 stem with foliage
130	3 stems, 1 color, with foliage
131	3 stems, different color, with foliage

Bellflower (Campanula)

Class	Description
132	Bellflower, 1 stem, any color
133	Bellflower, 3 stem, same color
134	Bellflower, 3 stems, different colors
135	Canterbury Bell, 1 stem

Bells Of Ireland (Moluccella Laevis)

Class	Description
136	3 stems

Bleeding Heart (Dicentra)

Class	Description
137	1 stem

Blue Lace Flower (Tachymene Coeruleaus)

Class	Description
138	1 stem

Calabrochoa (Million Bells)

Class	Description
139	1 stem
140	3 stems, 1 color
141	3 stems, different colors

Calendula

Class	Description
142	3 blooms, 1 color
143	3 blooms, different colors

Candytuft (Iberis Sempervirens)

Class	Description
144	Dwarf, 3 spikes
145	Tall, 3 spikes

Catmint (Nepeta Varieties)

Class	Description
146	3 stems, 1 color
147	3 stems, different colors

Chrysanthemum

Class	Description
148	Single, 3 blooms
149	Spoon, 3 blooms
150	Decorative, 3 blooms
151	Button, 3 blooms
152	One variety, as many different colors as possible
153	Collection, many types and colors

Shasta Daisy (Chrysanthemum Maximum)

Class	Description
154	Single, 3 blooms
155	Double, 3 blooms
156	Quilled, 3 blooms
157	Crested, 3 blooms
158	Spoon, 3 blooms
159	Collection, 3 different types

Feverfew (Chrysanthemum Parthenium)

Class	Description
160	Single, 1 stem
161	Single, 3 stems
162	Double, 1 stem
163	Double, 3 stems

Clarkia (Clarkia Amoena)

Class	Description
164	3 spikes, 1 color
165	3 spikes, different colors

Cleome

Class	Description
166	Rocky Mountain Bee Flower, 3 stems, 1 color
167	Any other Cleome, 1 stem

Cockscomb (Celosia)

Class	Description
168	Plume (C. plumosa), 1 stem
169	Crested (C. cristata), 1 stem

Columbine

Class	Description
170	Single, 1 stem
171	Single, 3 stems, 1 color
172	Double, 1 stem
173	Double, 3 stems, 1 color
174	As many different colors as possible

Coneflower

Class	Description
175	Echinacea purpurea, purple, 3 blooms
176	Echinacea purpurea var., white, 3 blooms
177	Any other Echinacea, 3 blooms

178	Ratibida columnifera, different colors, 3 stems
179	Ratibida columnifera, multi-colored, 3 stems
180	Ratibida columnifera, red, 3 stems
181	Ratibida columnifera, yellow, 3 stems
182	Rudbeckia fulgida (Goldstrum), 3 blooms
183	Rudbeckia hirta, (Glosiosa Daisy), 3 blooms, different colors
184	Rudbeckia hirta, double, 3 blooms, same color
185	Rudbeckia hirta, (Glosiose Daisy) single, (bi color) 3 blooms
186	Rudbeckia hirta, (Glosiosa Daisy), single, yellow, 3 blooms
187	Rudbeckia laciniata (Hortensia), 3 blooms
188	Rudbeckia nitida (Herbstonne), 3 blooms
189	Rudbeckia, any other, 3 blooms
190	Collection, any 3 coneflowers, 3 different colors
191	Collection, 3 coneflowers, different varieties

Coral Bells (Heuchera)

Class	Description
192	3 stems, 1 color
193	3 stems, different colors
194	Fancy leafed, 3 bloom stalks, 1 variety
195	Fancy leafed, 3 leaves, 1 variety
196	Fancy leafed, 3 leaves, different varieties
197	As many different colors as possible

Coreopsis

Class	Description
198	Grandiflora, double, 3 stems, 1 color
199	Grandiflora, single, 3 stems, 1 color
200	Tintoria, 3 stems, 1 color
201	Verticillata, 3 stems, 1 color

Cosmos

Class	Description
202	Orange/yellow, 3 stems
203	Pink/lavender, 3 stems
204	Purple/red, 3 stems
205	White, 3 stems
206	Different colors, 3 stems
207	Different colors, 5 stems
208	Any other color, 3 stems, same variety
209	As many different colors as possible

Cupid's Dart (Catananche Caerulea)

Class	Description
210	1 stem

Daisy

Class	Description
211	African (Dimorphotheca), 1 stem
212	Gazania, 1 stem
213	Gerbera, 1 stem
214	Painted Daisy (Pyrethrum roseum), 1 stem
215	Any daisy not listed elsewhere, 3 stems

Daylilly (Hemerocallis)

Class	Description
216	1 scape

Delphinium, Perennial

Class	Description
217	Elatum hybrids, 1 stem

- 218 Elatum hybrids, 3 stems, 1 color
 219 Elatum hybrids, 3 stems, different colors
 220 Grandiflorum, 1 stem
 221 Grandiflorum, 3 stems, 1 color
 222 Grandiflorum, 3 stems, different colors

Dianthus

Class Description

- 223 Carnation (*D. caryophyllus*), 3 stems, 1 color
 224 Carnation (*D. caryophyllus*), as many colors as possible
 225 Dianthus (*D. chinensis*), 3 stems, 1 color
 226 Dianthus (*D. chinensis*), 3 stems, different colors
 227 Dianthus (*D. chinensis*), 5 stems, 1 color
 228 Dianthus (*D. chinensis*), 5 stems, different colors
 229 Dianthus (*D. chinensis*), as many colors as possible
 230 Sweet William (*D. barbatus*), 1 stem
 231 Sweet William (*D. barbatus*), 3 stems, 1 color
 232 Sweet William (*D. barbatus*), 3 stems, different colors

Dusty Miller, Annual (*Senecio Cinerea*)

Class Description

- 233 1 stem, foliage only
 234 1 stem, foliage with bloom

Eupatorium

Class Description

- 235 1 stem
 236 3 stems

False Dragonhead (*Physostegia Virginiana*)

Class Description

- 237 1 stem

Fleabane (*Erigeron*)

Class Description

- 238 3 stems, 1 color
 239 3 stems, different colors

Forget-Me-Not (*Myosotis Sylvatica*)

Class Description

- 240 1 stem

Foxglove (*Digitalis*)

Class Description

- 241 1 spike
 242 3 spikes, different colors

Gaillardia

Class Description

- 243 3 blooms, 1 type, bi- or tri-colored
 244 3 blooms, 1 type, solid color
 245 As many different colors as possible

Geranium

Class Description

- 246 Common, 1 bloom
 247 Common, 3 blooms, different colors
 248 Common, 3 blooms, same
 249 Fancy Leafed, 1 bloom stem, with foliage
 250 Hardy (Perennial), 1 stem
 251 Hardy (Perennial), 3 stems, 1 color
 252 Hardy (Perennial), 3 stems, different colors
 253 Ivy Leafed, 1 bloom stem, with foliage

- 254 Scented, 1 bloom, with foliage
 255 Martha Washington, 1 bloom
 256 Martha Washington, 3 blooms, different colors

Globe Amaranth (*Gomphrena Globosa*)

Class Description

- 257 3 stems, same color
 258 3 stems, different colors

Grass, Ornamental

Class Description

- 259 5 stems, 1 variety, with flower/seed
 260 5 stems, 1 variety, foliage only
 261 10 stems, 1 variety, with flower/seed heads
 262 10 stems, 1 variety, foliage only
 263 10 stems, different varieties, dried
 264 As many different varieties as possible

Heliopsis

Class Description

- 265 Any variety, 3 blooms

Helianthus

Class Description

- 266 Any variety, other than annuus or maximilliani, 3 blooms

Hollyhock (*Alcea*)

Class Description

- 267 1 stalk, single
 268 1 stalk, double
 269 3 stalks, any type

Impatiens

Class Description

- 270 Single, 3 stems
 271 Double, 3 stems

Kale

Class Description

- 272 Ornamental, 1 head

Knautia

Class Description

- 273 1 stem
 274 3 stems, same

Larkspur, Annual (*Delphinium Ajacis*)

Class Description

- 275 1 stem
 276 3 stems, 1 color
 277 3 stems, different colors

Lavender (*Labiatae Lavendula*)

Class Description

- 278 3 stems

Liatris

Class Description

- 279 Purple, 1 stem
 280 White, 1 stem

Ligularia

Class	Description
281	1 stem, any variety

Lily

Class	Description
282	Asiatic, 1 stem
283	Auretum, 1 stem
284	Tiger, 1 stem
285	Oriental, 1 stem
286	Collection, 3 stems, same
287	Collection, 3 stems, different

Lobelia

Class	Description
288	(<i>L. erinus</i>), annual, 3 stems, 1 color
289	(<i>L. cardinalis</i>), perennial, 1 stem

Malva

Class	Description
290	1 stem, any variety

Marigold (Tagetes)

Class	Description
291	Small flowered, under 1 ½", 3 stems, yellow
292	Small flowered, under 1 ½", 3 stems, orange
293	Small flowered, under 1 ½", 3 stems, variegated/bi-color
294	Collection, small flowered, under 1 ½", different colors
295	Medium flowered, 1 ½" to 3", 3 blooms, yellow
296	Medium flowered, 1 ½" to 3", 3 blooms, orange
297	Medium flowered, 1 ½" to 3", 3 blooms, variegated/bi-color
298	Collection, medium flowered, 1 ½" to 3", different colors
299	Large flowered, over 3", 3 blooms, yellow
300	Large flowered, over 3", 3 blooms, orange
301	Collection, large flowered, over 3", different

Monarda

Class	Description
302	3 stems, 1 color
303	3 stems, different colors
304	Collection, as many colors as possible

Nasturtium (Tropaeolum)

Class	Description
305	3 stems, with foliage, 1 color
306	3 stems, with variegated foliage, 1 color
307	3 stems, different colors
308	As many colors as possible

Nicotiana

Class	Description
309	1 stem, 1 color

Penstemon

Class	Description
310	1 stem
311	3 stems, 1 variety
312	5 stems, 1 variety
313	3 stems, different varieties

314	5 stems, different varieties
315	As many different varieties as possible

Petunia

Class	Description
316	Single (Funnel Shaped), either ruffled or smooth edged, with open throats, 3 stems, 1 color
317	Double (Heavy Ruffled), 3 stems, 1 color
318	Single Grandiflora (very large flowers), 3 stems, 1 color
319	Double Grandiflora (very large flowers), 3 stems, 1 color
320	One variety, as many different colors as possible
321	As many different as possible

Phlox

Class	Description
322	Perennial, 1 stem
323	Perennial, 3 stems, 1 color
324	Perennial, 3 stems, different colors
325	Annual, 1 stem

Platycodon

Class	Description
326	1 stem
327	3 stems, 1 color

Poppy

Class	Description
328	California (<i>Eschscholzia californica</i>), 3 blooms
329	Iceland Poppy (<i>Papaver nudicaule</i>), 3 blooms
330	Oriental Poppy (<i>Papaver orientale</i>), 3 blooms
331	Shirley (<i>Papaver rhoeas</i>), 3 blooms
332	Any other Poppy, 1 stem

Russian Sage (Perovskia Atriplicifolia)

Class	Description
333	1 stem
334	3 stems, 1 color

Salvia

Class	Description
335	Annual, 3 stems, 1 color
336	Perennial, 3 stems, 1 color
337	Perennial, 3 stems, different colors

Scabiosa

Class	Description
338	3 blooms, 1 color
339	3 blooms, different colors
340	As many different colors as possible

Sedum (Spectabile)

Class	Description
341	"Autumn Joy", 1 stem
342	Any other, 1 stem

Sedum (Any Other)

Class	Description
343	1 stem
344	3 stems, 1 color
345	3 stems, different colors

Semperviren (Hen & Chicks)

- | Class | Description |
|-------|--------------------------------|
| 346 | Bloom stalk, 1 stem |
| 347 | Bloom stalk, 3 stem, different |

Snapdragon (Antirrhinum Majus)

- | Class | Description |
|-------|-----------------------------------|
| 348 | Dwarf, 3 spikes, 1 color |
| 349 | Dwarf, 3 spikes, different colors |
| 350 | Tall, 3 spikes, 1 color |
| 351 | Tall, 3 spikes, different colors |

Statice

- | Class | Description |
|-------|-----------------------------------|
| 352 | Annual, 3 stems, 1 color |
| 353 | Annual, 3 stems, different colors |
| 354 | Perennial, 1 stem |

Stocks (Matthiola)

- | Class | Description |
|-------|----------------------------|
| 355 | 3 spikes, one color |
| 356 | 3 spikes, different colors |

Sunflower

- | Class | Description |
|-------|---|
| 357 | Annual Sunflowers, as many colors as possible |
| 358 | Helianthus annuus, double, 3 stems |
| 359 | Helianthus annuus, mammoth variety, 1 bloom (may float in own bowl) |
| 360 | Helianthus annuus, single, red/maroon, 3 stems |
| 361 | Helianthus annuus, single, white, 3 stems |
| 362 | Helianthus annuus, single, yellow/orange, 3 stems |
| 363 | Helianthus maximilliani, perennial Maximillian's Sunflower, 1 stem |
| 364 | Tithonia rotundifolia, annual, Mexican Sunflower, 1 stem |
| 365 | Helianthus, any other |

Sweet Pea

- | Class | Description |
|-------|--|
| 366 | Annual, 3 stems, 1 color |
| 367 | Annual, 3 stems, different colors |
| 368 | Annual, 5 stems, 1 color |
| 369 | Annual, 5 stems, different colors |
| 370 | Annual, as many different colors as possible |
| 371 | Perennial, 3 stems, 1 color |
| 372 | Perennial, 3 stems, different colors |

Verbena

- | Class | Description |
|-------|-----------------------------------|
| 373 | Annual, 3 stems, 1 color |
| 374 | Annual, 3 stems, different colors |
| 375 | Perennial, 1 stem |

Veronica

- | Class | Description |
|-------|--------------------------------------|
| 376 | 3 stems, 1 color |
| 377 | 3 stems, different colors |
| 378 | 5 stems, 1 color |
| 379 | 5 stems, different colors |
| 380 | As many different colors as possible |

Viola

- | Class | Description |
|-------|---|
| 381 | Viola, 5 blooms, 1 color |
| 382 | Viola, 5 blooms, different colors |
| 383 | Viola, as many different colors as possible |
| 384 | Johnny Jump-Up type, 5 stems, 1 color |
| 385 | Johnny Jump-Up type, 5 stems, different colors |
| 386 | Johnny Jump-Up type, as many different colors as possible |
| 387 | Pansy, 5 blooms, 1 color |
| 388 | Pansy, 5 blooms, different colors |
| 389 | Pansy, as many different colors as possible |

Yarrow (Achillea)

- | Class | Description |
|-------|---|
| 390 | 3 stems, 1 color |
| 391 | 3 stems, cream/yellow/orange combination |
| 392 | 3 stems, pink/lavender/purple combination |
| 393 | 3 stems, different colors |
| 394 | 5 stems, cream/yellow/orange combination |
| 395 | 5 stems, pink/lavendar/purple combination |
| 396 | 5 stems, different colors |
| 397 | As many different colors as possible |

Zinnia

- | Class | Description |
|-------|--|
| 398 | Small Flowered, under 1 1/2" 3 blooms same color |
| 399 | Small Flowered, under 1 1/2" 3 blooms different colors |
| 400 | Medium Flowered, 1 1/2-3", 3 blooms same color |
| 401 | Medium Flowered, 1 1/2-3", 3 blooms different colors |
| 402 | Large Flowered, over 3", 1 bloom |
| 403 | Large Flowered, over 3", 3 blooms different colors |
| 404 | Cactus, 3 blooms, same color |
| 405 | Cactus, 3 blooms, different colors |
| 406 | Pinwheel, 3 blooms, same color |
| 407 | Pinwheel, 3 blooms, different colors |
| 408 | Pom Pom, 3 blooms, same color |
| 409 | Pom Pom, 3 blooms, different colors |
| 410 | As many different types and colors as possible |

Any Other Garden Flower

- | Class | Description |
|-------|---|
| 411 | 1 Specimen From Any Other Annual Flower Not Listed |
| 412 | 1 Specimen From Any Biennial Not Listed |
| 413 | 1 Specimen From Any Other Perennial Flower Not Listed |
| 414 | 1 Stem From A Bulb, Tuber Or Corn Not Listed. |

Collections

- | Class | Description |
|-------|--|
| 415 | Annuals, 3 stems, different varieties |
| 416 | Annuals, 5 stems, different varieties |
| 417 | Everlastings, 3 stems, different varieties |
| 418 | Everlastings, 5 stems, different varieties |
| 419 | Perennials, 3 stems, different varieties |
| 420 | Perennials, 5 stems, different varieties |
| 421 | Mixture of types, 5 stems |
| 422 | All blue, 3 stems |
| 423 | All red, 3 stems |
| 424 | All white, 3 stems |
| 425 | All yellow, 3 stems |
| 426 | Blue, white and yellow, 3 stems |
| 427 | Pink, lavender, purple, 3 stems |
| 428 | Red, white and blue, 3 stems |

- 429 Yellow, orange, red, 3 stems
 430 As many different types of flowers as possible

Dahlias

- | Class | Description |
|-------|---|
| 431 | Extra large, 1 bloom floated in your own bowl |
| 432 | Decorative, small, under 3", 1 bloom |
| 433 | Decorative, medium, 3" – 5", 1 bloom |
| 434 | Decorative, large, 5" – 7", 1 bloom |
| 435 | Decorative, giant, over 7", 1 bloom |
| 436 | Decorative, 3 blooms, same |
| 437 | Decorative, 3 blooms, different |
| 438 | Anemone, 1 bloom |
| 439 | Butterfly, 1 bloom |
| 440 | Cactus, 1 bloom |
| 441 | Cactus, 3 blooms, same |
| 442 | Cactus, 3 blooms, different |
| 443 | Pom-pom, 1 bloom |
| 444 | Water Lily, 1 bloom |
| 445 | Any other, not listed, 1 bloom |

Gladioli

- | Class | Description |
|-------|---|
| 446 | Hardy, 1 spike |
| 447 | Hardy, as many different colors as possible |
| 448 | Miniature, 1 spike |
| 449 | Miniature, 3 spikes, 1 color |
| 450 | Miniature, Collection, as many different colors as possible |
| 451 | Standard, 1 spike |
| 452 | Standard, 3 spikes, 1 color |
| 453 | Standard, Collection, as many different colors as possible |

Waterlily

- | Class | Description |
|-------|-------------|
| 454 | 1 stem |

ROSES

Hybrid Tea

- | Class | Description |
|-------|--------------------------------------|
| 455 | 1 bloom, with foliage |
| 456 | 3 blooms, with foliage, 1 color |
| 457 | As many different colors as possible |

Floribunda

- | Class | Description |
|-------|--------------------------------------|
| 458 | 1 stem, with foliage |
| 459 | 3 stems, with foliage, 1 color |
| 460 | As many different colors as possible |

Miniature

- | Class | Description |
|-------|--|
| 461 | 1 bloom, with foliage |
| 462 | 3 blooms, with foliage, 1 color |
| 463 | As many different colors as possible, with foliage |

Climbing

- | Class | Description |
|-------|--|
| 464 | Large flowered, natural, 1 bloom, with foliage |
| 465 | Climbing sport of Bush rose, 1 bloom, with foliage |

Rose (Name If Possible)

- | Class | Description |
|-------|------------------|
| 466 | Any antique rose |
| 467 | Any shrub rose |
| 468 | Any single rose |
| 469 | Any rose species |
| 470 | Any other rose |

Rose Collection

- | Class | Description |
|-------|---|
| 471 | 3 different varieties, 3 blooms, with foliage |

Ground Covers

- | Class | Description |
|-------|--|
| 472 | Ajuga (A. reptans), 3 stems, plain foliage, with or without flowers |
| 473 | Ajuga (A. reptans), 3 stems, variegated foliage, with or without flowers |
| 474 | Aegopodium (Bishop's Weed), 3 stems of foliage |
| 475 | Crown Vetch, 3 stems with flowers |
| 476 | Lamb's Ears (Stachys) 1 stem, with flowers |
| 477 | Lamb's Ears (Stachys) 1 stem, without flowers |
| 478 | Lamb's Ears (Stachys) 3 stems, with flowers |
| 479 | Lamb's Ears (Stachys) 3 stems, without flowers |
| 480 | Lamium (L. maculatum) 3 stems of foliage, same |
| 481 | Lamium (L. maculatum) 3 stems of foliage, different |
| 482 | Potentilla (P. tabernaemontani, verna) 3 stems of foliage, with or without flowers |
| 483 | Sedum 1 stem |
| 484 | Sedum 3 stems, one variety, with or without flowers |
| 485 | Sedum Collection, up to 5 different varieties, with or without flowers |
| 486 | Snow-On-The-Mountain (Euphorbia marginata) 3 stems, with or without flowers |
| 487 | Sweet Woodruff (Galium odoratum) 5 stems |
| 488 | Thyme with flowers, 3 stems |
| 489 | Thyme without flowers, 3 stems |
| 490 | Vinca (major) 3 stems, with or without flowers |
| 491 | Vinca (minor) 3 stems, with or without flowers |
| 492 | Vinca (variegated) 3 stems, with or without flowers |
| 493 | Any Other Ground Cover, 1 stem, with or without flowers |
| 494 | Any Other Ground Cover, 3 stems, with or without flowers |
| 495 | Collection 5 different varieties for ground covers, with or without flowers |

Shrubs And Vines

- | Class | Description |
|-------|--|
| 496 | Apache Plume - (Fallugia Paradoxa), 1 branch, not over 30" |
| 497 | Berried Shrub 1 spray, not over 30" |
| 498 | Butterfly Bush (Buddleia davidii), 1 branch, not over 30" |
| 499 | Clematis, 2 sprays, not over 36" |
| 500 | Fern Bush, (D. chamaebatiaria millefolium), 1 branch, not over 30" |
| 501 | Flowering Shrub 1 spray, not over 30" |
| 502 | Flowering Vine, 2 sprays, not over 36" |
| 503 | Hop Vine, 2 sprays, not over 36" |
| 504 | Potentilla (P. fruiticosa), 1 branch, not over 30" |
| 505 | Silverlace Vine (Polygonum aubertii), 2 sprays, not over 36" |
| 506 | Any Green Vine, 2 sprays, not over 36" |

Patio Pots (Containers Not To Exceed 24")

Class	Description
507	Annuals
508	Perennials
509	Herbs
510	Petunias
511	Succulents
512	Vegetables
513	Any Combination

POTTED HOUSE PLANTS

Potted plants must have been grown by the exhibitor for at least six (6) months before entry, and not have been a Blue Ribbon winner within the previous two years. Please identify your plant if you know what it is on the tag. Name and address of exhibitor should be placed on the underside of the container if possible.

African Violets (Saintpaulia)

Class	Description
514	Micro-miniature
515	Miniature, single crown, double bloom
516	Miniature, single crown, single bloom
517	Semi-miniature, single crown, double bloom
518	Semi-miniature, single crown, single bloom
519	Standard, single crown, double bloom
520	Standard, single crown, ruffled bloom
521	Standard, single crown, single bloom
522	Trailing
523	Variegated, any type

Begonia

Class	Description
524	Angel-wing
525	Rex
526	Tuberous

Cactus

Class	Description
527	Container under 7" in diameter (one plant)
528	Container over 7" in diameter (one plant)
529	Collection, more than one plant, same container

Christmas Cactus

Class	Description
530	Any type

Climbing And Trailing Plants (Not Listed)

Class	Description
531	Flowering, not over 10" in diameter
532	Foliage, not over 10" in diameter
533	Creeping Charlie (Swedish Ivy)
534	Wandering Jew

Container Gardens

Class	Description
535	Dish Garden, a landscape design in a shallow dish-like container, not to exceed 14" in diameter
536	Fairy Garden with miniatures, not to exceed 24" in diameter
537	Terrarium, curved glass or straight-sided, landscape

design in covered terrarium, mirrored back allowed
538 Natural Garden, a landscape design in a natural container, may have multiple planting areas

Ferns

Class	Description
539	Any variety

Flowering House Plants (Not Listed)

Class	Description
540	Any plant

Foliage Plants, Bushy And Upright (Not Listed)

Class	Description
541	Colored
542	Green
543	Rubber Plant
544	Variegated

Geraniums (Pelargonium)

Class	Description
545	Common
546	Fancy leaved
547	Ivy
548	Martha Washington
549	Scented

Hoya

Class	Description
550	Solid foliage
551	Varigated foliage

Ivy (Hedera)

Class	Description
552	Any ivy

Jade Plant

Class	Description
553	Green leafed
554	Varigated leafed

Kitchen Herbs

Class	Description
555	One in container, under 6" diameter
556	One in container, over 6 diameter
557	Collection

Orchids

Class	Description
558	Beefya (Hybrid)
559	Dendrobium (Hybrid)
560	Phalaenopsis (Moth Orchid)
561	Any other hybrid
562	Species

Oxalis (Shamrock)

Class	Description
563	Green leafed
564	Colored leafed
565	With flowers

Philodendron

Class Description
 566 Climbing or trailing
 567 Upright

Pothos

Class Description
 568 Climbing or trailing

String Of Hearts

Class Description
 569 Any variety

Succulents

Class Description
 570 Container under 7" in diameter (one plant)
 571 Container over 7" in diameter (one plant)
 572 Collection

Unusual or Novel Containers

(Containers not to exceed 12" width)

Class Description
 573 One plant
 574 Upright
 575 Vining or Trailing

Any Other Potted House Plant Not Listed

Class Description
 576 Any plant not listed

GOURDS**Green**

Class Description
 577 Pear, 3 gourds
 578 Crown Of Thorns, 3 gourds
 579 Next Egg, 3 gourds
 580 Any other small fruited, 3 gourds, same variety
 581 Small fruited mixed, 3 gourds
 582 Turk's Turban, 1 gourd
 583 Birdhouse, 1 gourd
 584 Dipper, 1 gourd
 585 Bushel, 1 gourd
 586 Any other large, 1 gourd
 587 Large fruited mixed, 3 gourds

Dried

Class Description
 588 Pear, 3 gourds
 589 Crown Of Thorns, 3 gourds
 590 Next Egg, 3 gourds
 591 Any other small fruited, 3 gourds, same variety
 592 Small fruited mixed, 3 gourds
 593 Turk's Turban, 1 gourd
 594 Birdhouse, 1 gourd
 595 Dipper, 1 gourd
 596 Bushel, 1 gourd
 597 Any other large, 1 gourd
 598 Large fruited mixed, 3 gourds

Special Thanks To Our 2022 Sponsors!

Friends of Coconino County Parks
 Mike and Sarah Cromer
 Northern Light Tree Co. & Landscape Maintenance LLC,
 Mike Pettay
 Viola's Flower Garden
 Warner's Nursery and Landscape Co.

Thank you 2022 Volunteers!

Cheryl Bruton	Jim Mast
Cindy Murray	Joe Kuczora
Connie Fletcher	Mary Walton
Debby Nash	Pat Johnson
Evan Burris	Patsy Workman
Faith Brittain	Sue Rathjen
Hugh Murray	Susan Holiday
Jack Johnson	Trudy Hope
Jallien Shield	Wayne Johnson
Jennifer Kuczora	

Thank you for the beautiful Displays!

Coconino County Master Gardeners
 Flagstaff Seed Library
 Native Plant Society
 Coconino Community College Community Garden
 Northern Arizona Organic Beekeepers Assoc.



Gems & Minerals

Department Code "GM"



Janet Findley, Superintendent
(928) 814-9337, janetfindley@npgcable.com

Entry Fee: \$0.00 / entry

Entry Forms Due: August 18

Receiving Date: August 27, 1 p.m. - 4 p.m.

August 31, 10 a.m. - noon (outside of Flagstaff)

Releasing Date: September 4, 4 - 4:30 p.m.

Department Rules

- All General Fair Rules apply.
- Do not put your name on the front of labels in any competitive exhibit.
- Ensure department class codes are entered on entry forms.
- All specimens exhibited must be the property of the exhibitor; and all lapidary work for competition must be the work of the exhibitor, except Class 133.
- Entries receiving blue ribbons from last year are not eligible for competition this year, but may be entered for exhibition only.
- Identification: Cabinet, museum, and miniature specimens must show on the label the name of the mineral and location.
- Cabochons, slabs, carvings, jewelry, etc., do not require complete labeling – it is necessary to identify the names of minerals used. Location may be given but is not required.
- No exhibit may be entered for more than one award; and **only one entry may be entered in any one class.**
- We encourage exhibitors to rearrange any previous display to give the show a new look or variety.
- Judging for all classes will be based on quality of specimens, variety of specimens, arrangement of exhibit, and labeling. All exhibits will be judged and awards made by class, by department class code.
- Professional and Commercial exhibits will be judged separately from Amateur exhibits. Decisions of the judges are final.
- Judging results submitted by judges and department superintendents are considered final.
- Exhibitors submitting five or more entries will receive one 1-day admission to the Fair.
- Ribbons will be awarded according to merit. All items are judged against items in the same class. Each class will be awarded one blue, one red, and one white ribbon.

Division Codes

(J) - Junior (12 years old and younger)

(T) - Teen (13-18 years old)

(A) - Adult (19 years and older)

Awards

First: Ribbon, Second: Ribbon, Third: Ribbon

Best of Show:

Adults:	Rosette
Teens:	Rosette
Juniors:	Rosette
Adults:	\$25
Teens:	\$25
Juniors:	\$25
Minerals:	\$25
Lapidary:	\$25
Jewelry:	\$25
Petrified Wood:	\$25
Fossils:	\$25



Sponsored by
**Friends of Coconino
County Parks**

Minerals

Class Description

- | | |
|-----|---|
| 100 | Thumbnails (1"x1"x1", but more than 1/4")/Miniatures (more than 1"x1"x1", but less than 3"x3"x3")/Cabinet specimens (none less than 3"x3"x3") |
| 101 | Museum size specimens (no less than 6"x6"x6") |
| 102 | Minerals of the same family, Minerals |
| 103 | Minerals of the same locality, Minerals |
| 104 | Coconino County, Minerals |
| 105 | Geodes and Nodules, Minerals |
| 106 | Crystals, Minerals |

Lapidary

Class Description

- | | |
|-----|--|
| 107 | Cabochons, mounted and unmounted, Lapidary |
| 108 | Cabochons, native Arizona material, Lapidary |
| 109 | Cabochons, 1 material, Lapidary |
| 110 | Polished slabs, Lapidary |
| 111 | Unpolished slabs, Lapidary |
| 112 | Spheres or eggs, Lapidary |
| 113 | Tumbled or polished stones, assorted, Lapidary |
| 114 | Any other, Lapidary |

Petrified Wood

Class Description

- | | |
|-----|-------------------------------|
| 115 | Polished, any, Petrified Wood |
| 116 | Rough, any, Petrified Wood |



Jewelry

Class	Description
117	All metal, made by exhibitor, Jewelry
118	Mounted gem stones, cut by exhibitor, Jewelry
119	Mountings by exhibitor, stone not by exhibitor, Jewelry
120	Mountings, stones made by exhibitor, Jewelry

Fossils

Class	Description
121	Vertebrates, Fossils
122	Invertebrates, Fossils
123	Plants, Fossils
124	General, Fossils

Creative Arrangements

Class	Description
125	Assorted materials, Creative Arrangements
126	Decorative setting, Creative Arrangements
127	Educational, Creative Arrangements
128	Geological formation, Creative Arrangements
129	Volcanic formation, Creative Arrangements

Marine Invertebrates

Class	Description
130	Corals, Marine Invertebrates
131	Shells, Marine Invertebrates
132	General (or mixed), Marine Invertebrates

Miscellaneous

Class	Description
133	Miscellaneous Items
134	Rock Collection, Found
135	Rock Collection, Purchased

Special Thanks To Our 2022 Sponsor!

Friends of Coconino County Parks



Hobbies & Collectibles

Department "HC"

Christina Rankin, Superintendent
(814) 515-5060, me458@yahoo.com



Andrea Guerrette, Superintendent
(928) 600-6146, aguerrette507@hotmail.com

Entry Fee: \$0.00 / entry

Entry Forms Due: August 18

Receiving Times: August 27, 12 - 4 p.m.

Releasing entries after: September 4, 4 p.m.

Department Rules

1. All General Fair Rules apply.
2. Only one entry per class per exhibitor.
3. All entries must be capable of being displayed on a shelf 12" wide, except:
 - a. Items that may be hung on the wall.
 - b. Items that may be mounted on their own legs.
4. For security concerns, we try to display all collections either under glass/lock and key or on a wall away from curious hands. For any questions on security, please contact the department Superintendent.
5. Projects made in connection with school, scouting, or other groups, should not be entered unless this is also a hobby that is pursued during leisure time outside the group.
6. All work on an exhibit must be done by the exhibitor in each class. An exception to this is the frame.
7. Superintendent may turn away entries that have not complied with rules.
8. Suggestions for displaying exhibits: Mount the exhibit in an attractive permanent manner and include labels or small cards that explain interesting details or unique characteristics of the exhibit. Be sure the exhibit is free from dust, mildew and odor. Make certain all parts and details of the exhibit are securely fastened in place or

in a secured environment. Be sure entry is in correct section and class. Wall mounted displays must have hanging hardware.

9. Judging results submitted by judges and department superintendents are considered final.
10. Exhibitors submitting five entries will receive one 1-day admission to the Fair.
11. Ribbons will be awarded according to merit. All items are judged against items in the same class. Each class will be awarded one blue, one red, and one white ribbon.
12. No previous blue ribbon winning Hobbies and Collectible entries from the Coconino County Fair are eligible to be judged again, but may be brought in for display only.

Division Codes

- (Y) - Youth (17 years old and under)
- (A) - Adult (18-and older)
- (PD) - Persons with disabilities (all ages)

Collections Are Judged On:

1. Extensiveness of collection
2. Quality of specimens
3. Uniqueness of specimens
4. Attractiveness of mountings
5. Completeness of labels
6. Imagination and entertainment values

Craft and Model Buildings Are Judged On:

1. Craftsmanship
2. Completeness of detail
3. Attractiveness of display
4. Originality of design
5. Imagination and entertainment values

Consideration is also given to the extent to which the general rules for entry have been followed.

Awards

First: Ribbon, Second: Ribbon, Third: Ribbon

Best of Show - Ribbon

Best Collection

Youth \$25

Adult \$35

Best Hobby

Youth \$25

Adult \$35

Best STEM \$25

Best Persons with

Disabilities \$25

People's Choice \$25

Peaks Woodturners Awards

Best Woodworking

Youth \$50

Adult \$50



Sponsored by
**Friends of
Coconino County
Parks**



Classes

Hobbies -Model entries must state the type of model.

Kit Building - A model built entirely from the original kit, nothing else added, with the exception of paint, and/or decals, and minor additions or changes.

Bash Kit - Combination of several kits to create something new and original.

Scratch Building - The use of any materials. A "nonkit".

Diorama - A scene telling a story and reproduced in three dimension by placing objects, figures, etc. in front of, or on a painted background - any model with additional scenery and related items.

A Diorama is limited to 324 square inches. All models in this category must be glued or attached firmly to a board or a piece of cardboard.

Hobbies -

- 100 Cosplay/Costume
- 101 Legos Kit Form
- 102 Legos Original Design
- 103 Models - People or Animals
- 104 Ecological Recycling - Unique Projects made from recycled material
- 105 Puzzles
- 106 Woodworking
- 107 Hobbies - Other

Collectibles -

- 108 Collections - Antique (All items must be at least 50 years old)
- 109 Collections - Modern
- 110 Card Collections
- 111 Coin Collection
- 112 Stamp Collection
- 113 Collections - Other

Collections of Hobbies -

- 114 Airplanes/Flying Machines
- 115 Boats and Ships
- 116 Vehicles
- 117 Railroads
- 118 Paper Crafts Kit Form
- 119 Paper Crafts Original Design
- 120 Science Fiction
- 121 Music Instruments
- 122 Woodworking
- 123 Metal Arts

STEM (Science, Technology, Engineering & Mathematics)

Entries must include self standing informative, legible description about the project no smaller than 16pt font and no longer than 3 paragraphs.

- 124 Scientific/Engineering Tools
- 125 Coding
- 126 Robotics
- 127 Math Projects
- 128 Space-Related Models
- 129 STEM - Other
- 130 Lego - Puzzle Box

Special Thanks To Our 2022 Sponsor!
Friends of Coconino County Parks

Thank you to our Volunteers on page 62.

Home Economics

Department Code "HE"



Christina Rankin, Superintendent
(814) 515-5060, me458@yahoo.com



Andrea Guerrette, Superintendent
(928) 600-6146, aguerrette507@hotmail.com

Entry Fee: \$0.00 / entry

Entry Forms Due: August 18

Receiving Date: August 29, 3 p.m. - 7 p.m.

Quilt Receiving Date: August 26, 9 a.m. - 12 p.m.

Releasing entries after: September 4, 4 p.m.

Department Rules

1. All General Fair Rules apply.
2. Exhibitors may only enter one item per class.
3. Items for exhibit must be taken directly to the Home Economics building. Completed entry tags for exhibit items will be available at the Home Economics building the time of receiving exhibits.
4. Ribbons will be awarded according to merit. All items are judged against items in the same class. Each item within each class may be awarded one blue, one red, one white ribbon.
5. The decisions of the judges are final and appeals will not be considered.
6. All exhibitors in this department must be residents of Coconino County.
7. All items entered in this department must be produced by the exhibitor. The one exception to this rule is an item entered into the group category. You must indicate if any portion of your finished work has been completed by anyone else other than yourself (i.e. framing, quilting, etc.).
9. All items must have been completed or prepared within the past year. Articles previously entered in the Coconino County Fair are not eligible for competition again.

10. No entry of same or similar type shall be entered in any other department.
11. It is the responsibility of the exhibitor to choose the appropriate class when entering items for judging. Items entered incorrectly may be disqualified from judging.
12. Some items have specific entry requirements (i.e. size limits, quantities, container). Please read requirements carefully.
13. Items may be disqualified by the judges if:
 - a. entry rules are not followed
 - b. item is soiled, stained or unsanitary
 - c. preserved foods are improperly processed or judged unsafe
 Note: Entries made primarily with eggs are not allowed.
14. Items must be picked up between 4 - 6 p.m. on the last day of the Fair.
15. Coconino County Parks and Recreation is not responsible for items not claimed by 6 p.m. on the last day of the fair.

Division Codes

(A) - Adult (16 years and older)

(PD) - Persons with disabilities

NOTE: There is no classification for youth in this department. Youth enter in Open Youth department.

Awards

First: Ribbon, Second: Ribbon, Third: Ribbon

Best of Show: Ribbon

Best of Show:

All Breads: \$15 cash award

Cakes: \$15 cash award

Decorated Cakes: \$15 cash award

Cookies: \$15 cash award

Pies: \$15 cash award

Preserved Foods: \$15 cash award

Honey: \$15 cash award

Needle & Fiber: \$15 cash award

Candy: \$15 cash award

Crafts: \$15 cash award

Quilts: \$15 cash award

People's Choice:

Quilts: \$20

Non-Quilts: \$20

Foods Classes

Rules: Please enter foods on plastic disposable plates, enclosed in sealed plastic bags (i.e. Zip-lock variety.) Read carefully for amounts required for entry. No entries with custard, cheese, uncooked egg, or meringue.



Sponsored by
**Friends of Coconino
County Parks**

Judging Criteria for Bread

Flavor	35%
Texture	35%
Appearance	25%
Color	5%

**Yeast Breads/Rolls - Traditional
(1/3 loaf or 3 rolls)**

Class	Description
100	French bread
101	French rolls
102	Gluten Free bread, any
103	Mixed grain bread
104	Mixed grain rolls
105	Sourdough bread
106	Sweet yeast bread
107	Sweet yeast rolls
108	Wheat bread, original recipe
109	Wheat rolls, original recipe
110	White bread, original recipe
111	White rolls, original recipe
112	Whole wheat bread
113	Whole wheat rolls
114	Miscellaneous

**Quick Breads
(1/3 Loaf Or 3 Pieces)**

Class	Description
115	Bagels
116	Banana bread
117	Any fruit
118	Vegetable, pumpkin
119	Vegetable, zucchini
120	Coffee cake
121	Cornbread
122	Muffins, any fruit
123	Muffins, miscellaneous
124	Muffins, unsweetened variety
125	Muffins, any vegetable
126	Regional Bread, biscuits (3)
127	Regional Bread, fry bread
128	Regional Bread, sopapillas (3)
129	Regional Bread, tamales, sweet (no meat)
130	Regional Bread, tortillas, corn (3)
131	Regional Bread, tortillas, flour (3)
132	Scones
133	Gluten Free, any
134	King Arthur Baking Special Baking Contest
Be sure to also fill out the entry form on page 63!	
135	Miscellaneous

Judging Criteria for Cakes

Texture, moisture, lightness	40%
General Appearance (shape, color)	30%
Flavor	30%

Cakes

(Two 3" pieces. No whole cakes or cheese-cakes accepted.)

Enter cakes on a plastic disposable plate inside a plastic zip-loc bag.

Class	Description
136	Angel cake
137	Carrot cake

138	Chocolate cake, frosted
139	Cupcakes, 4ea.
140	Fruit cake, traditional
141	Gluten Free, any
142	Pound cake
143	Spice or applesauce cake,
144	Sugar-free cake
145	White cake, frosted
146	Yellow cake, frosted
147	Zucchini cake
148	Other cake made with fruit
149	Miscellaneous

Judging Criteria for Decorated Cakes

Execution (workmanship) 30%

Originality 20%

Neatness (smooth, free from cracks) 15%

Eye-appeal (pleasing appearance, attractive) 15%

Uniformity (decoration spacing, symmetry) 10%

Correct Display (height, use of decorative items) 10%

Decorated Cakes - Fondant

(Base does not have to be edible)

Class Description

150	Any novelty cake
151	Any special occasion
152	Any other decorated miniature or cupcake
153	Miscellaneous

Decorated Cakes - Frosted

Class Description

154	Original design
155	Any cake

Judging Criteria For Cookies

Flavor 40%

Texture 25%

Appearance (uniform size and shape) 20%

Lightness 15%

Cookie Jar - Sponsored by Mozelle's Bakery

This category is a jar of assorted cookies. Jar may be any kind of wide-mouthed, transparent, jar, and decorated as desired. Jar to count 50% of judging, cookies to count 50% of judging. Jar not to be less than 6" or over 15" in height, not counting decorations. Jar should contain not less than 3 different varieties of cookies, must be partially filled, and must be made by the exhibitor. For judging purposes, one of each cookie must be in a zip-loc bag and stapled to the entry tag. Enter cookies on a disposable plastic plate inside a plastic zip-lock bag.

Class Description

156	Cookie jar
-----	------------

Cookies (Quantity - 5 Each)

Class Description

157	Bar cookies, brownie
158	Bar cookies
159	Drop cookies, chocolate
160	Drop cookies, chocolate chip
161	Drop cookies, miscellaneous

- 162 Drop cookies, oatmeal
- 163 Drop cookies, peanut butter
- 164 Drop cookies, sugar
- 165 Gingerbread cookie or house
- 166 No-bake cookie
- 167 Novelty cookie
- 168 Any rolled cookie
- 169 Gluten Free cookie, any
- 170 Miscellaneous Cookie, any style

Judging Criteria For Pies, Crisps & Cobblers

Flavor	40%
General Appearance	20%
Filling	20%
Crust	20%

Pies, Crisps & Cobblers (Quantity - ¼ Pie)

Enter pies on aluminum plate to prevent sogginess. Absolutely no custard, egg, cheese or cream pies.

Class	Description
171	Cobbler
172	Crisp
173	Tarts
174	Turnover, filled
175	Any fruit variety, Pies/Crisps/Cobblers
176	Miscellaneous, Pies/Crisps/Cobblers

Judging Criteria For Candy

Flavor	40%
Execution (workmanship)	25%
Neatness/Eye-appeal	20%
Uniformity	15%

Candies (Quantity - 5 Pieces)

Place on disposable plastic plate and seal in a zip-lock bag.

Class	Description
177	Brittle Candies
178	Dipped Candies
179	Divinity Candies
180	Fudge, any combo
181	Fudge, chocolate
182	No-cook Candies
183	Sucker/lollipop
184	Taffy
185	Candies, Miscellaneous

FOOD PRESERVATION

1. All entries must be labeled with:
 - a. Type of processing (water bath or pressure)
 - b. Date of canning (must be within the last 13 months)
 - c. Name of product
2. Any canned food will be disqualified if:
 - a. There is rust on the lid or the rim
 - b. Processing method was inappropriate or not indicated
3. No canned food will be accepted with paraffin.
4. All bands must be left on the lids.

Judging Criteria for Soft Spreads, Jellies, Jams, Preserves, etc.

30% - Appearance (color - characteristic of fruit; clearness - jellies translucent; container - glass, practical, clean sealed lids. Neat and properly labeled with pertinent info)

- 35% - Texture (jelly - tender, should quiver, cut easily and retain shape; preserves - pieces firm and whole, clear, thick syrup; marmalades - small, thin pieces, clear, thick syrup; fruit butters - fruit that has been pressed through a sieve, no separation of fruit and juice; jams - crushed fruit, no separation; conserves - similar to jam, but always contain a mixture of fruits and usually have nuts or raisins added.)
- 35% - Flavor (characteristic, without excessive sweetness or overcooked flavor.)

Fruit - Water Bath Method

Class	Description
186	Fruit (any), WBM
187	Fruit brandied (any combo), WBM
188	Fruit syrup (any), WBM
189	Tomatoes, WBM
190	Miscellaneous fruit, WBM

Sauces & Mixes

Class	Description
191	Apple Sauce
192	Barbeque Sauce
193	Cake Mix
194	Cookie Mix
195	Ice Cream Topping
196	Red Sauce (non-tomato)
197	Soup Mix
198	Tomato Sauce
199	White Sauce
200	Sauce, any other

Condiments & Spices

Class	Description
201	Catsup
202	Mustard
203	Oil
204	Salsa, mild
205	Salsa, medium
206	Spice Mix
207	Vanilla Extract
208	Vinegar

Nectars & Juices

Class	Description
209	Juice, any fruit
210	Juice, any vegetable
211	Nectar, any variety

Vegetables - Pressure Method

Class	Description
212	Beans, PM
213	Beets, PM
214	Carrots, PM
215	Corn, PM
216	Green chili, PM
217	Peas, PM
218	Squash, PM
219	Tomatoes, PM
220	Any other vegetable (combo), PM
221	Any other vegetable, PM
222	Any soup, PM
223	Miscellaneous Vegetables, PM

Preserves/Jams - Water Bath Method

Class	Description
224	Berry, any combination, WBM
225	Berry, any, WBM
226	Fruit, any variety, WBM
227	Fruit, any, WBM
228	Low/sugar free, any, WBM
229	Any combination preserves/jams, WBM
230	Any fruit preserves/jams, WBM
231	Miscellaneous perserves/jams, WBM

Jelly - Water Bath Method

Class	Description
232	Berry jelly, any combination, WBM
233	Berry jelly, any, WBM
234	Chili (red or green) jelly, WBM
235	Fruit jelly, any, WBM
236	Fruit jelly, combination, WBM
237	Mint jelly, WBM
238	Sugar free jelly, WBM
239	Wine jelly, WBM
240	Miscellaneous jelly, WBM

Fruit Spread – Water Bath Method

Class	Description
241	Butters, any, WBM
242	Conserve, any, WBM
243	Fruit spread, any, Reduced sugar, WBM
244	Orange marmalade, WBM
245	Spread, Any combo, WBM
246	Miscellaneous fruit spread, WBM

Judging Criteria For Pickles, Relishes, Sauces, Etc.

65% - Appearance (color uniform, attractive, characteristic of kind with no darkening on the top or discoloration of ingredients; size – whole or pieces of suitable, uniform size; liquid – clear with no scum on top; texture – plump, unbroken skins or flesh firm, not shriveled or overcooked. Not shriveled from excess salt, acid, or sugar.)

25% - Safety & Suitability (choice of fruit and/or vegetable that is safe and suitable for home canning or pickling)

10% - Container (tightly sealed, clear jars designed for canning of specific size, clean, neatly and properly labeled)

Pickles & Relishes – Water Bath Method

Class	Description
247	Beets, pickled, WBM
248	Chutney, WBM
249	Combination, pickled vegetables, WBM
250	Corn relish, WBM
251	Cucumber, pickled, any dill, WBM
252	Cucumber, pickled, any other, WBM
253	Cucumber, pickled, any sweet, WBM
254	Cucumber, pickled, bread and butter, WBM
255	Cucumber, pickled, relish, WBM
256	Fruit, pickled/spiced, any, WBM
257	Hot pickle, any variety, WBM
258	Peppers, pickled, WBM
259	Zucchini, pickled, any other, WBM
260	Zucchini, relish, any other, WBM
261	Zucchini, relish, combination, WBM
262	Miscellaneous pickled vegetables, WBM

263 Miscellaneous pickles & relishes, WBM

Beer, Wine & Liqueurs

Class	Description
264	Beer, dark
265	Beer, light
266	Beer, any other
267	Hard Cider
268	Liqueur, any
269	Mead
270	Wine, any other
271	Wine, red
272	Wine, white
273	Ciders, non-alcoholic
274	Sodas
275	Root Beer

Judging Criteria For Dried Food

Flavor	50%
Texture	20%
Color (same & uniform)	20%
Uniform Size	10%

Dried Fruit & Vegetables

Please Note: Enter dried herbs in the Agriculture & Horticulture Department of the Fair.

Dried Fruits

(Quantity: at least 10 each in a half pint or pint canning jar)

Class	Description
276	Dried Fruits, Any
277	Dried Fruits, Any combination
278	Dried Fruits, Any other varietal
279	Fruit leather, any
280	Strawberries, dried
281	Dried Fruits, Miscellaneous dried fruits

Dried Vegetables

(Quantity: ½ cup in a half pint or pint canning jar)

Class	Description
282	Tomatoes, dried
283	Dried Vegetables, Any
284	Dried Vegetables, Miscellaneous

Dried Meats

(Quantity: approximately 5 sticks)

Class	Description
285	Game, any, dried
286	Jerky, beef
287	Jerky, game
288	Any other dried meats

Honey Products

These entries must be made with the majority of sweetener being honey.

Class	Description
289	Breads, quick (w/honey)
290	Breads, yeast, bread maker (w/honey)
291	Breads, yeast, traditional (w/honey)
292	Candy, any other variety (w/honey)
293	Candy, dipped (w/honey)
294	Candy, fudge (w/honey)
295	Candy, no-bake (w/honey)

- 296 Cookies, bar (w/honey)
- 297 Cookies, drop (w/honey)
- 298 Cookies, no-bake (w/honey)
- 299 Cookies, pressed or molded (w/honey)
- 300 Cookies, rolled (w/honey)
- 301 Muffins (w/honey)
- 302 Rolls, yeast, traditional (w/honey)
- 303 Miscellaneous honey products

CLOTHING

Please indicate if your garment was constructed with a Serger by marking your entry form with "srg".

Clothing Classes For Adults

Includes natural fibers, knits, and knit blends.

- | Class | Description |
|-------|-------------------------------------|
| 304 | Bathing suit, Adult |
| 305 | Blouse/Tops, Adult |
| 306 | Casual wear, Adult |
| 307 | Costume, Adult |
| 308 | Dress, long, Adult |
| 309 | Dress, short, Adult |
| 310 | Evening dress, long, Adult |
| 311 | Evening dress, short, Adult |
| 312 | Historical Undergarments, Adult |
| 313 | Jacket or blazer, Adult |
| 314 | Jeans, Adult |
| 315 | Kilts Skirt, Adult |
| 316 | Lingerie/Lounge wear, Adult |
| 317 | Man's jacket, Adult |
| 318 | Man's shirt, Adult |
| 319 | Outer wear, Adult |
| 320 | Skirt, Adult |
| 321 | Slacks/shorts, Adult |
| 322 | Suit, lined, Adult |
| 323 | Suit, unlined, Adult |
| 324 | Vest, Adult |
| 325 | Wedding dress, Adult |
| 326 | Any garment, original design, Adult |
| 327 | Any two-piece outfit, Adult |
| 328 | Any western wear item, Adult |
| 329 | Any Recycled Material Item |
| 330 | Miscellaneous Adult |
| 331 | Facemask, Adult |

Clothing For Children and Infants

Includes any natural, knit, or knit-based fibers.

- | Class | Description |
|-------|--|
| 332 | Bathing suit, Child/Infant |
| 333 | Beach wear, Child/Infant |
| 334 | Bibs, Child/Infant |
| 335 | Blouse/tops, Child/Infant |
| 336 | Christening Outfit, Child/Infant |
| 337 | Costume, Child/Infant |
| 338 | Coveralls, Child/Infant |
| 339 | Dress, long, Child/Infant |
| 340 | Dress, short, Child/Infant |
| 341 | Hat or Bonnet, Child/Infant |
| 342 | Jumper, Child/Infant |
| 343 | Layette Set, Child/Infant |
| 344 | Nightwear, Child/Infant |
| 345 | Original design, Child/Infant |
| 346 | Outer wear, Child/Infant |
| 347 | Outfit, any 2 or 3 piece set, Child/Infant |

- 348 Pants or jeans, Child/Infant
- 349 Shorts, Child/Infant
- 350 Skirt/shirt, Child/Infant
- 351 T-shirt, Child/Infant
- 352 Vest, Child/Infant
- 353 Western wear, Child/Infant
- 354 Facemask, Child/Infant
- 355 Misc garment, Child/Infant

Needle & Fiber Arts

All needle arts entries should indicate whether it is a Kit or Your Own, Original Design, or Pattern Book. Indicate if it is self, or commercially framed or finished. Picture measurement is determined by the work itself, excluding the frame. If a portion of your project is assisted by another please indicate and attach detachable pieces securely.

Judging Criteria For Needle & Fiber Arts

- 75% - Workmanship (complexity of pattern; execution of pattern; uniform stitches & design; construction precision)
- 25% - Appearance (cleanliness, pressing or blocking; suitability of color, pattern and fabric; overall visual impact)

Crochet

- | Class | Description |
|-------|------------------------------------|
| 356 | Accessory, Crochet |
| 357 | Afghan, baby, Crochet |
| 358 | Afghan, Crochet |
| 359 | Baby item, Crochet |
| 360 | Bedsread, Crochet |
| 361 | Bootie, Crochet |
| 362 | Cap, hat, or head cover, Crochet |
| 363 | Child's item, Crochet |
| 364 | Christmas, Crochet |
| 365 | Coat, Crochet |
| 366 | Collar, Crochet |
| 367 | Doily, Crochet |
| 368 | Doll clothes, Crochet |
| 369 | Dress, Crochet |
| 370 | Holiday item, Crochet |
| 371 | Home accessory, Crochet |
| 372 | Layette ensemble, Crochet |
| 373 | Outfit (2 or more pieces), Crochet |
| 374 | Pillow, Crochet |
| 375 | Poncho, Capelet, Shrug, Crochet |
| 376 | Rug, Crochet |
| 377 | Shawl/stole, Crochet |
| 378 | Slipper, Crochet |
| 379 | Sweater, any adult, Crochet |
| 380 | Tablecloth, Crochet |
| 381 | Toy, Crochet |
| 382 | Vest, Crochet |
| 383 | Miscellaneous Crochet item |

Knitting

- | Class | Description |
|-------|----------------------------------|
| 384 | Accessory, home, Knitting |
| 385 | Accessory, Knitting |
| 386 | Afghan, Knitting |
| 387 | Bedsread, Knitting |
| 388 | Bootie, Knitting |
| 389 | Cap, hat or head cover, Knitting |

- 390 Child item, Knitting
- 391 Christmas item, Knitting
- 392 Coat, Knitting
- 393 Doll clothes, Knitting
- 394 Doll, Knitting
- 395 Dress, Knitting
- 396 Infant item, Knitting
- 397 Lace, Knitting
- 398 Layette, Knitting
- 399 Loom knit, Knitting
- 400 Machine knit, Knitting
- 401 Poncho, Capelet, Shrug, Knitting
- 402 Rug, Knitting
- 403 Shawl or stole, Knitting
- 404 Slipper, Knitting
- 405 Sock, Knitting
- 406 Sweater, Knitting
- 407 Tablecloth, Knitting
- 408 Toy, Knitting
- 409 Vest, Knitting
- 410 Miscellaneous, Knitting item

Hand-Spun Yarn

- | Class | Description |
|-------|--------------------------|
| 411 | Hand-dyed and spun yarn |
| 412 | Hand-spun crocheted item |
| 413 | Hand-spun knitted item |
| 414 | Hand-spun yarn |

Tatting

- | Class | Description |
|-------|--------------|
| 415 | Tatting, Any |

Weaving

- | Class | Description |
|-------|------------------------------|
| 416 | Accessory, home, weaving |
| 417 | Accessory, personal, weaving |
| 418 | Basket, weaving |
| 419 | Clothing, weaving |
| 420 | Decorative item, weaving |
| 421 | Purse, weaving |
| 422 | Miscellaneous weaving item |

Felting

- | Class | Description |
|-------|-------------------------|
| 423 | Hats, felting |
| 424 | Saddle blanket, felting |
| 425 | Slippers, felting |
| 426 | Any other felting item |

Beading

- | Class | Description |
|-------|----------------------------|
| 427 | Bracelet, beading |
| 428 | Earring, beading |
| 429 | Necklace, beading |
| 430 | Ornament, beading |
| 431 | Purse, beading |
| 432 | Ring, beading |
| 433 | Miscellaneous beading item |

Braiding Or Wrapping

- | Class | Description |
|-------|----------------|
| 434 | Braided item |
| 435 | Reg-point, any |

- 436 Wrapped item, any
- 437 Miscellaneous braided or wrapped item

Ewe & Wool

Items must have been made by exhibitor and of 100% wool. (Wool can be sheep, Angora goat, Angora rabbit, beaver, camelid, alpaca and cashmere.) Linings do not need to be made of wool.

- | Class | Description |
|-------|--------------------------|
| 438 | Accessories, wool |
| 439 | Clothing, wool |
| 440 | Hats, wool |
| 441 | Rugs, wool |
| 442 | Saddle blankets, wool |
| 443 | Saddle pads, wool |
| 444 | Miscellaneous wool items |

Counted Cross Stitch

Measurement dimensions shown for classes below are the size of the needlework itself. Use class number which approximate to the closest size listed. Do not include the frame size. Indicate if it is self or commercially framed or finished.

- | Class | Description |
|-------|---|
| 445 | Accessory, home, CCS |
| 446 | Christmas, CCS |
| 447 | Clothing, CCS |
| 448 | Holiday (any other), CCS |
| 449 | Linen, CCS |
| 450 | Ornament, CCS |
| 451 | Picture, small, CCS (4"x6" or 20" perimeter or smaller) |
| 452 | Picture, medium, CCS (perimeter of 20"-25" 5"x7 max) |
| 453 | Picture, large, CCS (perimeter of 26"-36" 8"-10") |
| 454 | Picture, extra large, CCS (perimeter of 37" and up) |
| 455 | Pictures, set, CCS |
| 456 | Sampler, any, CCS |
| 457 | Tear-away canvas, CCS |
| 458 | Wall hanging/banner, CCS |
| 459 | Miscellaneous Counted Cross Stich |

Crewel

- | Class | Description |
|-------|------------------------------|
| 460 | Accessory, crewel |
| 461 | Baby/Child, crewel |
| 462 | Christmas, crewel |
| 463 | Holiday (any other), crewel |
| 464 | Picture, small, crewel |
| 465 | Picture, medium, crewel |
| 466 | Picture, large, crewel |
| 467 | Picture, extra large, crewel |
| 468 | Related set, crewel |
| 469 | Miscellaneous crewel |

Hand Embroidery

- | Class | Description |
|-------|-----------------------------|
| 470 | Baby/Child, hand embroidery |
| 471 | Christmas, hand embroidery |

- 472 Clothing, hand embroidery
 473 Decorative, hand embroidery
 474 Holiday (any other), hand embroidery
 475 Home Accessory, bedspread/quilt/afghan, hand
 476 Home Accessory, miscellaneous, hand embroidery
 477 Home Accessory, pillowcase, hand embroidery
 478 Home Accessory, tablecloth/runner/mats, hand
 479 Picture/wall hanging, small, hand embroidery
 480 Picture/wall hanging, medium, hand embroidery
 481 Picture/wall hanging, large, hand embroidery
 482 Picture/wall hanging, extra large, hand embroidery
 483 Related set, any, hand embroidery
 484 Miscellaneous Hand Embroidery

Smocking

- | Class | Description |
|-------|--------------------------|
| 485 | Accessory item, smocking |
| 486 | Clothing item, smocking |
| 487 | Miscellaneous smocking |

Needlepoint And Canvas Work

- | Class | Description |
|-------|---|
| 488 | Accessory, home, needlepoint/canvas |
| 489 | Accessory, personal, needlepoint/canvas |
| 490 | Baby/Child, needlepoint/canvas |
| 491 | Bergello/Florentine, needlepoint/canvas |
| 492 | Christmas, needlepoint/canvas |
| 493 | Clothing, needlepoint/canvas |
| 494 | Hand-painted canvas, needlepoint/canvas |
| 495 | Holiday (any other), needlepoint/canvas |
| 496 | Picture, needlepoint/canvas |
| 497 | Plastic canvas, needlepoint/canvas |
| 498 | Toy, needlepoint/canvas |
| 499 | Miscellaneous needlepoint/canvas |

Miscellaneous Needle Arts

- | Class | Description |
|-------|---|
| 500 | Battenburg lace, Misc needle arts |
| 501 | Candlewicking, home accessory, Misc needle arts |
| 502 | Candlewicking, miscellaneous, Misc needle arts |
| 503 | Cutwork, Misc needle arts |
| 504 | Hardanger, Misc needle arts |
| 505 | White on white, Misc needle arts |
| 506 | Miscellaneous Needle Arts |

Ribbon Embroidery

- | Class | Description |
|-------|---------------------------------|
| 507 | Clothing, ribbon embroidery |
| 508 | Holiday, ribbon embroidery |
| 509 | Pillow, ribbon embroidery |
| 510 | Miscellaneous Ribbon Embroidery |

Sewn/Fabric Arts Or Novelty Items

- | Class | Description |
|-------|---|
| 511 | Baby item, Sewn/Fabric or Novelty |
| 512 | Belt, Sewn/Fabric or Novelty |
| 513 | Carriers, backpacks, luggage, baby carriers, purses, Sewn/Fabric or Novelty |
| 514 | Child item, Sewn/Fabric or Novelty |
| 515 | Christmas, Sewn/Fabric or Novelty |
| 516 | Frame, misc, Sewn/Fabric or Novelty |
| 517 | Frame, single, Sewn/Fabric or Novelty |
| 518 | Holiday (any other), Sewn/Fabric or Novelty |
| 519 | Photo Album, padded, Sewn/Fabric or Novelty |

- | | |
|-----|---|
| 520 | Picture frame, padded, Sewn/Fabric or Novelty |
| 521 | Soft box, Sewn/Fabric or Novelty |
| 522 | Tablecloth, runner, placemats, Sewn/Fabric or Novelty |
| 523 | Wall hanging, Sewn/Fabric or Novelty |
| 524 | Wreath, Sewn/Fabric or Novelty |
| 525 | Pillow Case |
| 526 | Pet Costume |
| 527 | Miscellaneous Sewn/Fabric or Novelty Items |

Judging Criteria For Dolls/Stuffed Animals

- 75% - Workmanship (complexity of pattern; execution of pattern; uniform stitches & design; construction precision)
 25% - Appearance (cleanliness; suitability of color, pattern and fabric; overall visual impact)

Dolls/Stuffed Animals

Entries will be judged on original design, creativity, innovation and unique dolls, etc. Costuming and workmanship will also be evaluated.

- | Class | Description |
|-------|----------------------------------|
| 528 | Doll, Clothes |
| 529 | Doll, Historical |
| 530 | Doll, Miniature |
| 531 | Doll, Original design |
| 532 | Doll, Original design, set |
| 533 | Doll, Pattern |
| 534 | Doll, Pattern, set |
| 535 | Doll, Porcelain, commercial mold |
| 536 | Doll, Porcelain, hand sculpted |
| 537 | Doll, Porcelain, original mold |
| 538 | Doll, Soft sculpture |
| 539 | Stuffed animal |

Applique

- | Class | Description |
|-------|---------------------------|
| 540 | Accessory, home, applique |
| 541 | Clothing, applique |
| 542 | Decorative, applique |
| 543 | Miscellaneous Applique\ |

Patchwork (No Quilting)

- | Class | Description |
|-------|---------------------------|
| 544 | Accessory, patchwork |
| 545 | Clothing, patchwork |
| 546 | Decorative, patchwork |
| 547 | Home accessory, patchwork |
| 548 | Miscellaneous Patchwork |

Tied Bed Cover

- | Class | Description |
|-------|---------------------------------------|
| 549 | Baby, original design, tied bed cover |
| 550 | Baby, pre-stamped, tied bed cover |
| 551 | Child, tied bed cover |
| 552 | Full size, cotton, tied bed cover |
| 553 | Full size, tricot, tied bed cover |
| 554 | Patchwork/crazy quilt, tied bed cover |
| 555 | Miscellaneous Tied Bed Cover |

CRAFTS

Entries which are framed or intended for hanging must be properly wired for hanging.

Stenciling

Class	Description
556	Christmas, stenciling
557	Holiday, any other, stenciling
558	Home Accessory, stenciling
559	Miscellaneous Stenciling

Tole Painting

Class	Description
560	Tole Painting, any

Miscellaneous Crafts

Class	Description
561	Misc Crafts, Batik
562	Corn husk, dolls
563	Dough art
564	Latchwork
565	Lockerhock
566	Painted fabric
567	Paper ribbon art, decorative item
568	Punchwork
569	Soaps - animal fat
570	Soaps - glycerin, molded
571	Soaps - vegetable fat
572	Windsocks
573	Wreath
574	Miscellaneous Crafts

QUILTING**Receiving for quilts is only August 28, 9 a.m. - 12 p.m.**

For proper display, quilts must have a 4" hanging sleeve, loops, or other means of hanging attached to back at or near the top. The top of hanging sleeves or loops must be positioned no farther than 90" from the bottom edge of the quilt to ensure it will not drag on the floor when displayed. Hanging sleeves should not be wider than 93" to accommodate hanging on a 96" rod. Any quilt wider than 96" will be gathered to display on a 96" rod unless entrant supplies a wider rod to be used for display of their quilt.

QUILTS WITHOUT APPROPRIATE HANGING SLEEVES, LOOPS OR OTHER MEANS FOR HANGING, WILL BE DISQUALIFIED AND NOT DISPLAYED.

Each major Quilt and Wall Hanging category will have multiple class descriptions. For each one, you must select one of the following:

- Hand Quilted: Quilted by hand by entrant. Made entirely by entrant, including construction of top, quilting, and finishing.
- Machine Quilted: Quilted by machine by entrant. Made entirely by entrant, including construction of top, quilting, and finishing.
- Professionally Quilted: Quilting done by paid/bartered arrangement by professional and/or long arm quilter. Any quilt completed by employing the services of a professional quilter must be entered in a "Professionally Quilted" class. This includes any quilt done for the exchange of money or barter. Please include name of commercial quilter in the

description of the entry.

- 2 or more Persons: Quilt made by more than 1 person. Hand quilted or machine quilted. Excludes professionally quilted.

Judging Criteria For Quilts

- 75% - Workmanship (complexity of pattern; execution of pattern; uniform stitches & design; construction precision)
- 25% - Appearance (cleanliness; suitability of color, pattern and fabric; overall visual impact)

BED QUILTS

Must measure greater than 270" around the perimeter and may be in hand, home machine, or commercially machine quilted (see below).

Wholecloth Bed Quilts

Class	Description
575	Hand Quilted, Wholecloth Bed
576	Machine Quilted, Wholecloth Bed
577	Professionally Quilted, Wholecloth Bed
578	2 or more Persons, Wholecloth Bed
579	Bed Set (Quilt & Pillow Cases)

Specialty Technique Bed Quilts

Including trapunto, embroidered, other specialty techniques.

Class	Description
580	Hand Quilted, Specialty Technique Bed
581	Machine Quilted, Specialty Technique Bed
582	Professionally Quilted, Specialty Technique Bed
583	2 or more Persons, Specialty Technique Bed
584	Bed Set

Pieced Bed-Size Quilts

Quilt may include minor appliqued elements but must be pre-dominantly pieced.

Class	Description
585	Hand Quilted, Pieced Bed-Size
586	Machine Quilted, Pieced Bed-Size
587	Professionally Quilted, Pieced Bed-Size
588	2 or more Persons, Pieced Bed-Size
589	Bed Set

Appliqued Bed-Size Quilts

Entries must be predominantly appliqued.

Class	Description
590	Hand Quilted, Appliqued Bed-Size
591	Machine Quilted, Appliqued Bed-Size
592	Professionally Quilted, Appliqued Bed-Size
593	Two or more Persons, Appliqued Bed-Size
594	Bed Set

Modern Bed Quilts

Class	Description
595	Hand Quilted, Modern Bed Quilts
596	Machine Quilted, Modern Bed Quilts
597	Professionally Quilted, Modern Bed Quilts
598	Two or more Persons, Modern Bed Quilts
599	Bed Set

LARGE WALL QUILTS

Entries in these categories measure greater than 200" but less than 270" around the perimeter and may be hand or

machine quilted by one individual.

Wholecloth Large Wall Quilts

Class	Description
600	Hand Quilted, Wholecloth Large Wall
601	Machine Quilted, Wholecloth Large Wall
602	Professionally Quilted, Wholecloth Large Wall
603	2 or more Persons, Wholecloth Large Wall

Specialty Technique Large Wall Quilts

Including trapunto, embroidered, other specialty techniques.

Class	Description
604	Hand Quilted, Specialty Technique Large Wall
605	Machine Quilted, Specialty Technique Large Wall
606	Professionally Quilted, Specialty Technique Large Wall
607	2 or more Persons, Specialty Technique Large Wall

Pieced Large Wall Quilts

Entries may include minor appliqued elements.

Class	Description
608	Hand Quilted, Pieced Large Wall
609	Machine Quilted, Pieced Large Wall
610	Professionally Quilted, Pieced Large Wall
611	2 or more Persons, Pieced Large Wall

Appliqued Large Wall Quilts

Entries may include minor pieced elements.

Class	Description
612	Hand Quilted, Appliqued Large Wall
613	Machine Quilted, Appliqued Large Wall
614	Professionally Quilted, Appliqued Large Wall
615	2 or more Persons, Appliqued Large Wall

Modern Large Wall Quilts

Class	Description
616	Hand Quilted, Modern Large Wall Quilts
617	Machine Quilted, Modern Large Wall Quilts
618	Professionally Quilted, Modern Large Wall Quilts
619	Two or more Persons, Modern Large Wall Quilts

MEDIUM WALL QUILTS

Entries in these categories measure greater than 100" but less than 199" around the perimeter and may be hand or machine quilted by one individual.

Wholecloth Medium Wall Quilts

Class	Description
620	Hand Quilted, Wholecloth Medium Wall
621	Machine Quilted, Wholecloth Medium Wall
622	Professionally Quilted, Wholecloth Medium Wall
623	2 or more Persons, Wholecloth Medium Wall

Specialty Technique Medium Wall Quilts

Including trapunto, embroidered, other specialty techniques.

Class	Description
624	Hand Quilted, Specialty Technique Medium Wall
625	Machine Quilted, Specialty Technique Medium Wall
626	Professionally Quilted, Specialty Technique Medium Wall
627	2 or more Persons, Specialty Technique Medium Wall

Pieced Medium Wall Quilts

Entries may include minor appliqued elements.

Class	Description
628	Hand Quilted, Pieced Medium Wall
629	Machine Quilted, Pieced Medium Wall
630	Professionally Quilted, Pieced Medium Wall
631	2 or more Persons, Pieced Medium Wall

Appliqued Medium Wall Quilts

Entries may include minor pieced elements.

Class	Description
632	Hand Quilted, Appliqued Medium Wall
633	Machine Quilted, Appliqued Medium Wall
634	Professionally Quilted, Appliqued Medium Wall
635	2 or more Persons, Appliqued Medium Wall

Modern Medium Wall Quilts

Class	Description
636	Hand Quilted, Modern Medium Wall Quilts
637	Machine Quilted, Modern Medium Wall Quilts
638	Professionally Quilted, Modern Medium Wall Quilts
639	Two or more Persons, Modern Medium Wall Quilts

SMALL WALL QUILTS

Entries in these categories measure smaller than 100" around the perimeter and may be hand or machine quilted by one individual.

Wholecloth Small Wall Quilts

Class	Description
640	Hand Quilted, Wholecloth Small Wall
641	Machine Quilted, Wholecloth Small Wall
642	Professionally Quilted, Wholecloth Small Wall
643	2 or more Persons, Wholecloth Small Wall

Specialty Technique Small Wall Quilts

Including trapunto, embroidered, other specialty techniques.

Class	Description
644	Hand Quilted, Specialty Technique Small Wall
645	Machine Quilted, Specialty Technique Small Wall
646	Professionally Quilted, Specialty Technique Small Wall
647	2 or more Persons, Specialty Technique Small Wall

Pieced Small Wall Quilts

Entries may include minor appliqued elements.

Class	Description
648	Hand Quilted, Pieced Small Wall
649	Machine Quilted, Pieced Small Wall
650	Professionally Quilted, Pieced Small Wall
651	2 or more Persons, Pieced Small Wall

Appliqued Small Wall Quilts

Entries may include minor pieced elements.

Class	Description
652	Hand Quilted, Appliqued Small Wall
653	Machine Quilted, Appliqued Small Wall
654	Professionally Quilted, Appliqued Small Wall
655	2 or more Persons, Appliqued Small Wall

Modern Small Wall Quilts

Class	Description
656	Hand Quilted, Modern Small Wall Quilts
657	Machine Quilted, Modern Small Wall Quilts
658	Professionally Quilted, Modern Small Wall Quilts
659	Two or more Persons, Modern Small Wall Quilts

SPECIAL CATAGORIES

Entries in these categories may be any size unless specified and may be hand or machine quilted by one individual.

Art Quilts

Class	Description
660	Small Wall, Art Quilts
661	Medium Wall, Art Quilts
662	Large Wall, Art Quilts
663	Art Quilts, any

Barn Quilts

A barn quilt is a large, hand -painted wooden quilt block typically displayed on the front or side of a barn; smaller barn quilts can be displayed indoors. Entries must measure not less than 2' x 2' and not more than 4' x 4' square and can be painted on a wood base or a stretched artist's canvas. Barn quilts must have a sturdy picture hanging wire attached to the back for display

Class	Description
664	Barn Quilts

Miniature Quilts

Miniature versions of large quilt patterns. Blocks measure 4" or smaller.

Class	Description
665	Pieced, Miniature Quilts
666	Appliqued, Miniature Quilts
667	Embellished, Miniature Quilts

Children's Theme/Crib Quilts

Quilts using any technique and designed as a crib quilt or as a children's quilt. Must measure less than 270" around the perimeter.

Class	Description
668	Hand Quilted, Child's Theme / Crib Quilts
669	Machine Quilted, Child's Theme / Crib Quilts
670	Professionally Quilted, Child's Theme / Crib Quilts
671	2 or more Persons, Child's Theme / Crib Quilts

First Time Quilt

Quilt must be the first quilt the entrant has made. Quilt must have been made in the past year, hand or machine quilted, completed entirely by one individual.

Class	Description
672	Bedsized, First Time Quilt
673	Wall hanging, First Time Quilt



Quilted Accessories/Garment

Excludes holiday decorations.

Class	Description
674	Clothing, Quilted Accessories/Garment
675	Table Runner, Placemats, etc., Quilted Accessories/Garment
676	Tote Bags, Purses, Backpacks, Quilted Accessories/Garment
677	Miscellaneous Quilted Accessories/Garment

Coconono Quilters' Guild Challenge

The Coconino Quilters Guild is sponsoring a small theme based quilting category open to all quilters.

The 2023 theme is "Northern Arizona."

Create a quilt that represents the theme using any quilting technique(s) desired. Entries must be no larger than 18" x 24" and must be constructed using a top, batting and backing. Embellishments and/or additional layers are encouraged. This challenge is open to all Coconino County quilters.

Cash prizes will be awarded:

1st - \$50, 2nd - \$25, 3rd - \$10.

Judging criteria:

- Originality 20%
- Design 20%
- Representation of the theme 20%
- Overall appearance 20%
- Workmanship 20%

Class Description

678	Coconino Quilters' Guild Challenge
-----	------------------------------------

Special Thank You to Our 2022 Sponsor!

Friends of Coconino County Parks

Thank you 2022 Hobbies and Collectibles & Home Economics Volunteers!

Anna Kuykendall
 Barb Branton
 Beth Levi
 Bruce Huntzinger
 Damion Glassy
 Dave Fitzgerald
 Deb Neumayr
 Donna Fitzgerald
 Emmaline Tsosie
 Gale Glassy
 Grace Ellis
 Jason Kordosky
 Jem Field
 Kathie Coolidge
 Kristin Boyes
 Linda Kucera

Lori Scandura
 Maddie Sieg
 Mary Knight
 Pam Hamilton
 Parker Stanley
 Phil Hamilton
 Rebecca Crawford
 Rexanna Smith
 Shannon Wells
 Sharon Huntzinger
 Sherry Phillips
 Sierra Helton
 Sue Dawson
 Sylvia Struss
 Wendy Wetzal



King Arthur Baking Special Baking Contest!

SPECIAL COCONINO COUNTY FAIR ENTRY

Quick Breads

Coconino County Fair, September 1-4, 2023

Home Economics and Open Youth Class

Open to:

Juniors- Ages 8 – 15 to show in Open Youth • Adults- Ages 16 and up to show in Home Economics

King Arthur Baking Prizes

All QUICK BREAD winners will receive a gorgeous ribbon.

Adult Category - QUICK BREADS

1st place: \$75 gift card

2nd place: \$50 gift card

3rd place: \$25 gift card

Junior Category - QUICK BREADS

1st place: \$40 gift card

2nd place: \$25 gift card

3rd place: King Arthur Baking Tote Bag

In addition, all winners receive a ribbon.

Rules:

1. Complete required entry form (see below).
2. Submit completed entry form with QUICK BREADS on: **Tuesday, August 29 between 3 p.m. and 7 p.m.**
3. Prepare your favorite Quick Bread recipe using any type of King Arthur Baking – creativity strongly encouraged. No mixes or prepared frosting allowed. The complete recipe, preferably typed, must accompany your entry.
4. Exhibitor must affix the King Arthur Baking UPC label from the flour bag or proof of purchase to the entry form he/she submits.
5. An entry form must accompany the entry.
6. Please submit 1/3 loaf or 3 slices on a disposable plate for judging.
7. Judging will be based on the following criteria:

a. Flavor	50 points
b. Appearance	25 points
c. Texture	25 points
TOTAL	100 points
8. Failure to follow the rules may result in disqualification.

.....
KING ARTHUR BAKING QUICK BREADS CONTEST ENTRY FORM

NAME (first, middle initial, last)

MAILING ADDRESS

PHONE

AGE

CITY

STATE

ZIP

EMAIL ADDRESS

CONTACT NUMBER

AGE (check one):

Between 8 – 15 (Juniors)

16 or older (Adults)

Submit entries on Tuesday, August 29 between 3 p.m. and 7 p.m.

Adults - submit entry at Home Economics Building

Juniors - submit entry at Open Youth Building (Check Open Youth for times)

Attach with this Entry Form

King Arthur Baking UPC label from the flour bag or proof of purchase, i.e. receipt; The complete recipe, preferably typed.

Junior Beef

Department Code "JB"

Troy Mortensen, Superintendent.
(928) 699-6298, troymortensen30@yahoo.com

Entry Fee: \$0.00 / entry

Entry Forms Due: July 7
Receiving: Aug. 31, 9 a.m. - 4 p.m.
Market and Breeding Beef Conformation: Sept. 1, 1:30 p.m.
Market Steer Showmanship: Sept. 1, 2:30 p.m.
Breeding Cattle Show: Sept. 1, 7:30 p.m.

WEIGHT LIMITS: The maximum weight for Market Steer is unlimited, the minimum weight is 900 pounds.

Department Rules

- General Livestock Rules and 4-H Livestock Rules apply.**
- Those showing market beef must have a current Youth Livestock Quality Assurance Certificate.
- Feeding, watering, and cleaning of pens can only be done by the exhibitor and assisted by another 4-H exhibitor
- No tubing or otherwise filling of animals by any artificial means will be allowed.
- No nose rings or nose clamps. Exhibitors must be able to handle animal, alone, with one lead rope, to the satisfaction of the superintendent. Removal from fairgrounds may be required if animal is so unruly that it constitutes a hazard.

Junior Market Steer Rules

- All market and breeding cattle will be divided into equitable weight classes for judging.
- Steers must be secured by both neck and rope halters at all times, except during show preparation and show.

Junior Arizona Bred and Fed Market Steer Rules

- Junior Market Steer rules apply to the AZ Bred and Fed class.
- The AZ Bred and Fed Market steer must be purchased within the state of Arizona.
- The AZ Bred and Fed market steer must not have been bred by means of Artificial Insemination.
- The AZ Bred and Fed market steer cannot be from a

registered herd.

- Bill of sale from place of purchase will be required for proof upon entering animal into the market class, along with the State required Season Pass.

Junior Beef Showmanship

Awards

First: Ribbon, Second: Ribbon, Third: Ribbon	
Senior Beef Showmanship:	Award
Reserve Senior Beef Showmanship:	Award
Junior Beef Showmanship:	Award
Reserve Junior Beef Showmanship:	Award
Novice Beef Showmanship:	Award
Reserve Novice Beef Showmanship:	Award
Grand Champion Heifer:	Award
Reserve Champion Heifer:	Award
Herdsman:	Award

Class

Showmanship classes do not require a breed class code on the entry form.

Class	Description
100	Senior Beef Showmanship
101	Junior Beef Showmanship
102	Novice Beef Showmanship (1st year only, Junior & Senior)

Junior Market Beef

Awards

First: Ribbon, Second: Ribbon, Third: Ribbon	
Grand Champion Market Steer:	Award
Reserve Grand Champion Market Steer:	Award
Grand Champion AZ Bred and Fed Market Steer:	Award
Reserve Grand Champion AZ Bred and Fed Market Steer:	Award

Class

Class	Description
103	Market Steer
105	Heifer Class
106	Arizona Bred and Fed Market Steer

Many Thanks To Our 2022 Award Sponsors!





Flagstaff's Leading Veterinary Hospital

Aspen Veterinary Clinic is proud to have served the Flagstaff Community for everything pet related for over 45 years. Our experienced, compassionate veterinarians assisted by a talented team of highly-trained support staff are pleased to offer you the very best in veterinary medical care and customer service.

Aspen Veterinary Clinic offers a wide variety of services for your companion and large animals. Species include but are not limited to:

dogs, cats, birds, rabbits, "pocket pets," reptiles, horses and other equids, cows, small ruminants, camelids, swine and poultry, even wildlife species!

The clinic is open daily from 8:00AM - 5:30PM.

We have an on-call veterinarian available 24 hours a day, 365 days a year for emergencies.

Call us at **(928) 526-2423** to schedule an appointment today!

<https://www.aspenvetflagstaff.com/>

Address: 7861 U.S. 89 Flagstaff, AZ 86004

Junior Camelid

Department Code "JL"



Eric Souders, Superintendent
(928) 606-2110

Entry Fee: \$0.00 / entry

Entry Forms Due: July 7

Receiving Date: August 31, 12 - 5 p.m.

Showmanship: September 1, 5 p.m.

Costume Show: September 3, 6 p.m.

Obstacle Course Show: September 4, 10 a.m.

Department Rules

1. **General Livestock Rules and 4-H Livestock Rules apply.**
2. Pens are available and must be cleaned by 9 a.m. every day & after the closing of the fair, Monday, 4 p.m.
3. Show Rules:
 - a. All camelids shall be presented for judging with a halter and lead rope; no additional decorations.
 - b. Nursing camelid dams cannot be accompanied by their babies in the ring. (We recommend not showing nursing mothers.)
 - c. Unruly animals (or handlers) may be dismissed from the ring by the Judge, Ring Master, or Superintendent.
 - d. All camelids must be shown in correct age or sex classification (except where noted in class description).
 - e. No ranch, personal, animal or organizational name, logo, or insignia shall be displayed on the exhibitor or animal during the class. Only your number tag, which will be issued to you at check-in, is permitted.
 - f. Animals may be entered in only one halter class division.
 - g. Large classes may be divided for judging at the request of the judge. Only one set of awards for the entire class will be given.
 - h. Animals may not be moved from one class to another after judging has begun (except at the judge's discretion).
 - i. Exhibitors are responsible for being at the show tent 10 minutes prior to scheduled time of their class.
 - j. Handler attire should be conservative, neat and appropriate for the class. Shoes should be appropriate for the show ring (open-toed shoes, sandals and bare feet will disqualify the exhibitor). Suggested attire is dark pants and white shirt or blouse with nothing hanging from pockets.
 - k. Once in the ring, handler may not switch animal

being shown, which will result in dismissal from the ring.

l. The name of the handler and the name of the animal must match the names on the entry form.

4. All Junior Camelid exhibitors must be 4-H members in good standing and enrolled in a camelid project.

Division Codes

(JR) - Ages 8 – 13

(SR) - Ages 14 – 19

Awards

First: Ribbon, Second: Ribbon, Third: Ribbon

Junior Award

Plaque to be presented at Junior Fair Awards Programs

Junior Camelid Showmanship Awards

Senior Showmanship:	Award
Reserve Senior Showmanship:	Award
Junior Showmanship:	Award
Reserve Junior Showmanship:	Award
Novice Showmanship:	Award

Class

Class	Description
100	Junior Showmanship
101	Senior Showmanship

Junior Performance Camelids Awards

Best Packing Camelid:	Award
Best Costume Camelid:	Award

Class

Class	Description
102	Obstacle
103	Costume

Many Thanks To Our 2022 Sponsors!



Junior Club Work

Department Code "JC"

Vacant

Entry Fee: \$0.00 / entry

Entry Forms Due: August 4

Receiving: August 30, 4 - 7 p.m. and

August 31, 9:30 a.m. - 4 p.m.

Member Record Books: August 31 by 2 p.m.

Department Rules

1. All General Fair Rules apply.
2. All members are expected to exhibit at least one article in each project in which they are enrolled. Members may enter any number of classes (unless otherwise indicated), but only one entry per class will be accepted.
3. Members may exhibit only in the project areas in which they are enrolled. They may enter exhibits that have been made during the current 4-H year only.
4. A duplicate exhibit CANNOT be entered in the Youth Department by a 4-H member.
5. Judging is generally based on standards of the 4-H project manuals and the Danish system of judging will be used.
6. Entries will be released 4 - 5 p.m. the last day of the Fair. Exhibitors who have a 2-hour or more drive may pick up entries starting at 2:30 p.m. on the last day.

Division Codes

(SR) – Senior Member (14 year and older as of Jan. 1st)

(JR) – Junior (8-13 years old)

(N) – Novice (1st year only)

Awards

First: Ribbon, Second: Ribbon, Third:	Ribbon
Best of Show:	Ribbon
Grand Champion Senior Record Book:	Ribbon
Grand Champion Junior Record Book:	Ribbon
Best of Show Display/ Demonstration:	Ribbon
Club Entries Contest:	Trophy
Club Display- Peoples Choice:	Award

Educational Exhibits

This section has been included so the Fair Book can be flexible enough to accommodate all 4-H exhibits. Posters made exclusively for demonstrations or illustrated talks should be entered in Demonstration or Illustrated Talk. Livestock articles or exhibits should be entered in Livestock Craft Classes.

Class	Description
100	Any article or educational exhibit made in the project year suitable for exhibit.
101	Any article or educational exhibit made in the project year suitable for exhibit.
102	Any article or educational exhibit made in the project year suitable for exhibit.
103	Any article or educational exhibit made in the project year suitable for exhibit.
104	Any article or educational exhibit made in the project year suitable for exhibit.

105	Any article or educational exhibit made by one or more members in the same project group
106	Any article or educational exhibit made by the entire community club.
107	Any article or educational exhibit made by the entire project group

Clothing, Sewing & Textiles

Class	Description
108	Book bag or tote bag
109	Hemmed dish towel
110	Apron
111	Skirt with elastic casing
112	Chef's Apron
113	Any other clothing item using techniques learned
114	Educational exhibit related to project learning
115	Any other garment using techniques learned
116	Any other garment using techniques learned

Livestock Craft

Class	Description
117	Any educational exhibit in conjunction with project
118	Any other educational exhibit

Leather

Class	Description
119	Educational display on leather craft, first year
120	Personal leather article - first year
121	Any other leather article (not personal) - first year
122	Any article made during project year
123	Any article made during project year

Woodworking

Class	Description
124	Cutting board
125	Any article made during project year, first year
126	Any article made during project year, second year
127	Any article made during project year, third year
128	Any other article made during project year

General Arts And Crafts

Class	Description
129	Any article made during project year
130	Any article made during project year
131	Any article made during project year
132	Any art made during project year from fabric
133	Any article made during project year from fabric
134	Any article made during project year from glass
135	Any article made during project year from leather
136	Any article made during project year from metal
137	Any article made during project year from natural materials
138	Any article made during project year from paper
139	Any article made during project year from plaster
140	Any article made during project year from clay
141	Any article made during project year from wood
142	Any article made during project year from beads
143	Any article made during project year for Spring
144	Any article made during project year for Summer
145	Any article made during project year for Fall
146	Any article made during project year for Winter
147	Any article made during project year for Valentine's Day

- 148 Any article made during project year for St. Patrick's Day
 149 Any article made during project year for Easter
 150 Any article made during project year for Mother's Day
 151 Any article made during project year for Memorial Day
 152 Any article made during project year for Father's Day
 153 Any article made during project year for Fourth of July
 154 Any article made during project year for Halloween
 155 Any article made during project year for Thanksgiving
 156 Any article made during project year for Christmas
 157 Any other article made during project year for Christmas

Fine Arts

All pictures to be exhibited must be ready to hang (with hook)

- | Class | Description |
|-------|--|
| 158 | Oils and tempera original |
| 159 | Oils and tempera copy (partial or entire) |
| 160 | Watercolor, original |
| 161 | Watercolor, copy (partial or entire) |
| 162 | Pencil sketch, original |
| 163 | Pencil sketch, copy (partial or entire) |
| 164 | Charcoal, original |
| 165 | Charcoal, copy (partial or entire) |
| 166 | Pen and ink, original |
| 167 | Pen and ink, copy (partial or entire) |
| 168 | Pastels, original |
| 169 | Pastels, copy (partial or entire) |
| 170 | Elective other than classes listed above |
| 171 | Music – Recording of music, include written description of goals for the project and how long you have been playing this instrument. |

Needlecrafts/Weaving/Crocheting/Knitting

- | Class | Description |
|-------|--|
| 172 | Any embroidered article: kit |
| 173 | Any other embroidered article |
| 174 | Any counted cross-stitched item |
| 175 | Needlepoint item, kit |
| 176 | Needlepoint item, own design |
| 177 | Liquid embroidery or stenciling, own design |
| 178 | Liquid embroidery or stenciling, kit |
| 179 | Any woven item |
| 180 | Any other woven item |
| 181 | Any crocheted article |
| 182 | Any other crocheted article |
| 183 | Any knitted item made during project year |
| 184 | Any other knitted item made during project year |
| 185 | Any knitted item – beginner |
| 186 | Any knitted item – intermediate |
| 187 | Any knitted item – advanced |
| 188 | Any other entry in this category |
| 189 | Any quilted personal item—any case, purse, cosmetic bag, wallet, wearable, etc. |
| 190 | Any quilted home accessory item—any technique: table topper/runner, pillow, holiday item, etc. |
| 191 | Small pieced quilted wall hanging—perimeter must measure less than 144 inches |
| 192 | Small applique quilted wall hanging—perimeter must measure less than 144 inches |
| 193 | Large pieced quilted wall hanging or throw quilt—perimeter must measure at least 144 inches and not more than 270 inches |
| 194 | Large applique quilted wall hanging or throw quilt— |

- perimeter must measure at least 144 inches and not more than 270 inches
 195 Bed quilt, any technique—perimeter must measure more than 270 inches
 196 Any specialty technique quilted item; wholecloth, trapunto, hand or machine embroidery, etc.
 197 Art quilt, any size, any combination of techniques, surface embellishment, non-traditional finishing/mounting techniques, etc.
 198 Any sample quilt blocks
 199 Rag quilt
 200 Non-batting sewing item
 201 4-H barn curtains
 202 Any other project in conjunction with quilting

Demonstration or Illustrated Talk

- | Class | Description |
|-------|---|
| 203 | Educational exhibit used for a demonstration |
| 204 | Compact exhibit of other equipment used in presentation |
| 205 | Exhibit on how to give a presentation |

Junior Floriculture

Exhibits that can be entered include all classes found in the "Open" Floriculture Department. 4-H members are asked to enter their flowers in this division if they are enrolled in any type of gardening or plant project for flowers. Use the following numbers as 4-H Floriculture, but follow any other directions found in the Floriculture Department.

- | Class | Description |
|-------|---|
| 206 | Perennials |
| 207 | Succulents |
| 208 | Herbs |
| 209 | Vegetables |
| 210 | Any Combination |
| 211 | Standard, single crown, single bloom |
| 212 | Standard, single crown, ruffled bloom |
| 213 | Standard, single crown, double bloom |
| 214 | Semi- miniature, single crown, single bloom |
| 215 | Semi- miniature, single crown, double bloom |
| 216 | Miniature, single crown, single bloom |

Food Preparation

Please exhibit food on a paper plate and cover with a plastic bag. Attach two (2) 3"x5" cards to all foods entries. On card one, indicate the name of the food product and the recipe or method of processing if food is preserved. On card two, indicate the name of the food product and three primary nutritional contributions of the food to the human body. Foods requiring refrigeration will not be accepted for display. You must submit card one and card two with each perishable food entry. It will stay with the ribbon for display.

Nutrition/Education Exhibit

- | Class | Description |
|-------|-----------------------------------|
| 217 | Breakfast around the world |
| 218 | Consumer shopping display |
| 219 | Food for athletes |
| 220 | Measuring techniques |
| 221 | Any other poster or display topic |
| 222 | Recipe box |

Any Baked Good Class By A...

Class	Description
223	Junior member (9-10 years)
224	Intermediate member (11-13 years)
225	Senior member (14-18 years)
226	Junior member – any other item
227	Intermediate member– any other item
228	Senior member– any other item

Any Yeast Bread Baked By A...

Class	Description
229	Junior member – any other item
230	Intermediate member – any other item
231	Senior member – any other item

Cake Decorating - Unit One

Class	Description
232	Cupcakes (3)
233	Birthday cake
234	Gingerbread house
235	Novelty cake

Educational Exhibit

Class	Description
236	Display of borders
237	Display of designs
238	Recipe collection of icings and cakes

Cake Decorating - Unit Two

Class	Description
239	Birthday cake
240	Valentine cake
241	Mother's/Father's/Grandparent's Day cake
242	Christmas cake
243	Novelty cake
244	Theme cake
245	Gingerbread house
246	Overall learning experience

Cake Decorating - Unit Three

Class	Description
247	Easter egg or ornament
248	Cake using sugar mold
249	Tiered cake on risers
250	Novelty cake
251	Original design, decorated product
252	Special occasion cake
253	Gingerbread house
254	Any other product, decorated
255	Educational display
256	Overall learning experience

Food Preservation

Note: Jams, jellies, relishes, and pickles will be opened for judging. Fruits, meats, and vegetables will not be opened. Canned foods should be in containers no larger than pints if possible.

Class	Description
257	Any salsa
258	Any pickle
259	Any relish
260	Any vegetable
261	Any jam

262	Any preserve
263	Any marmalade
264	Any reduced sugar project
265	Any other canned or dried food
266	Any item - beginner
267	Any item - intermediate
268	Any item - advanced
269	Miscellaneous item not mentioned above
270	Educational exhibit
271	Overall learning experience
272	Any fruit leather
273	Any vegetable leather
274	Any meat/jerky
275	Any other leather
276	Dried herbs

**House Plants, Horticulture, & Agriculture
Container Plants - Name Varieties Entered**

Class	Description
277	House plant, grown for its foliage
278	Flowering house plant
279	Terrarium
280	Window box display
281	Vegetables
282	Herbs
283	Cactus/succulent(s)
284	Medicinal plant(s)

Agriculture And Horticulture - Name varieties entered

Exhibits that can be entered in this broad group include all classes found in the Open Agriculture and Horticulture Department. 4-H members are asked to enter their produce in the Junior Clubwork Building. Use the class numbers below but follow any other directions found in the open Agriculture and Horticulture department.

Class	Description
285	Any fruit or vegetable
286	Any other fruit or vegetable
287	Any other fruit or vegetable
288	Landscape beautification poster, picture or drawing exhibit of actual project
289	Plant study 22" by 28"- educational exhibit of one plant species
290	Gardening experiment- poster or compact exhibit showing any experiment carried out during the year
291	Plant science – poster or compact exhibit depicting some phase of learning.

Photography

Poster with multiple prints are to be mounted on posted or matt boards not to exceed 22" x 28". Color or black and white photographs may be used in each class.

Phase One

Class	Description
292	Exhibit of pictures (5 or more types of pictures)
293	A poster telling a story with pictures, such as a 4-H activity, event or project
294	An 8" x 10", 8" x 8" or 6" x 10" enlargement.
295	Any other exhibit from this phase

Phase Two

Class Description

- 296 Exhibits of pictures (5 or more types of pictures.)
 297 A poster telling a story with pictures, such as a 4-H activity, event or project
 298 An 8" x 10", 8" x 8" or 6" x 10" enlargement.
 299 Any other exhibit from this phase

Phase Three

Class Description

- 300 Exhibits of pictures (5 or more types of pictures)
 301 A poster telling a story with pictures, such as a 4-H activity, event or project
 302 An 8" x 10", 8" x 8" or 6" x 10" enlargement.
 303 Any other exhibit from this phase

Advanced Phase

Class Description

- 304 Exhibits of pictures (5 or more types of pictures.)
 305 A poster telling a story with pictures such as a 4-H activity, event or project
 306 An 8" x 10", 8" x 8" or 6" x 10" enlargement.

Performing Arts

Class Description

- 307 Any recognized exhibit made during project year
 308 Any recognized exhibit made during project year
 309 Any educational exhibit
 310 Any other exhibit or display

Public Speaking

Class Description

- 311 Any recognized exhibit made during project year
 312 Any recognized exhibit made during project year
 313 Any educational exhibit
 314 Any other exhibit or display

Record Books

Club entries: Club should use their club's name and community club leader's address for entry of their club scrap books and secretary's books.

Class Description

- 315 Club Secretary's Book
 316 Club Scrap Book
 317 Individual Scrap Book
 318 Individual Record Book - entries will be judged on the current 4-H year. The record book will be judged on its neatness, attractiveness, and completeness of all required sections.
 The 4-H story will also be considered for judging using the following questions as criteria:
 What do you think you have learned this year? What were the hard parts and best parts of your 4-H year? What would you have done differently, if anything, in your project? How did you meet your goals?

Shooting Education - Archery, Shotgun, Small Bore Pistol, Small Bore Rifle

Class Description

- 319 Arrow made in project
 320 Any arrow made in project
 321 Any other arrow made in project
 322 Any item made in project
 323 Any other item made in project
 324 Educational Exhibit

Veterinary Science

Class Description

- 325 Any recognized exhibit made during project year, by group
 326 Any recognized exhibit made during project year, by an individual

STEM

Class Description

- 327 Backyards and Beyond
 328 Computer Science
 329 Electricity
 330 Environmental Science
 331 Forestry
 332 Geo-spatial
 333 Robotics
 334 Lego Robotics
 335 Small Engines
 336 Welding
 337 Wildlife
 338 Rocketry
 339 Any article or project display made during project year with a STEM focus
 340 Other than classified

CloverBuds**Division Code: CK**

Youth who are 5 to 8 years of age and are enrolled as 4-H CloverBuds may exhibit in this division. CloverBuds is a non-competitive program so entries in the following CloverBuds classes will receive participation ribbons. CloverBuds may not enter in any other 4-H class.

Class Description

- 400 Individual CloverBuds exhibit made or used during the year
 401 Individual CloverBuds exhibit made or used during the year
 402 CloverBuds Club exhibit made or used during the year
 403 CloverBuds Club exhibit made or used during the year
 404 CloverBuds Club exhibit made or used during the year

Junior Wool Wool Entry Rules

1. All wool must have been collected after February 1, 2023 from an animal that you owned at the time and still own.
2. Each fleece should be in a large, clear (untied) plastic bag. Fleeces need to be skirted. Angora Rabbit wool is to be entered in 1oz. packages in a clear plastic bag.
3. No more than three entries per class per person.
4. White wool and colored wool will be judged separately.
5. Wool will be on exhibit in the Clubwork Building.
6. Wool exhibits may be offered for sale.
7. Wool must be checked out at the Clubwork building by the exhibitor. Superintendent will give exhibitor or purchaser a release slip.

Awards

Best Fleece: Award

First: Ribbon, Second: Ribbon, Third: Ribbon

Junior Wool Breed Codes

(L) - White

(M) - Natural Color, Solid

(N) - Natural Color, Variegated

Class

Class Description

341 Fine, natural, solid

342 Medium, natural, solid

343 Coarse, natural, solid

344 Hair or Fur Breeds (Karakul, Navajo Churro, etc.), natural, solid

Junior Wool Specialty Fibers

Class Description

345 Alpaca, natural, solid

346 Angora (rabbit), natural, solid

347 Cashmere, natural, solid

348 Camelid, natural, solid

349 Other, natural, solid



Many Thanks To Our 2022 Sponsors!



Junior Goat

Department Code "JG"

Lori Willman, Superintendent
(928) 699-9590

Entry Fee: \$0.00 / entry

Entry Forms Due: July 7

Receiving: Aug. 31, 9 a.m. - 4 p.m.

Market Goat Conformation: Sept. 1, 4 p.m.

Market & Breeding Showmanship: Sept. 1, 4 p.m.

Pet, Pack & Dairy Goat Show: Sept. 3, 10 a.m.

This department is open to all 4-H dairy, non-dairy, and market goats.

WEIGHT LIMITS: The maximum weight for Market Goat is unlimited, the minimum weight is 60 pounds.

Department Rules

- 1. General Livestock Rules and 4-H Livestock Rules apply.**
- Those showing in dairy and market classes must have a current Youth Livestock Quality Assurance Certificate.
- Goats must be clipped prior to arriving at the Fair. Goat grooming and touch up will be allowed only in the designated area. See rule #3 of the National Show Ring Code of Ethics for Coconino County.
- It is recommended that lead equipment consist of a small link collar properly fitted. Bells are not allowed.
- Barn duty for each day of the Fair is required of every 4-H member entering their goat in the Fair.
- All ages of goats are based on the date of the show.
- IN-STATE: All goats must not be infected with Blue-tongue nor exposed to scrapie or originate from a scrapie infected source or herd.
- Exhibitors are required to dress in white, long sleeved shirt and black pants. Hats are not permitted.

Wether goats less than 18 months of age are exempt from the official scrapie identification requirement. The health certificate must state that they are not infected with Blue-tongue, nor exposed to scrapie, or originate from a scrapie infected or source flock. All goats will be checked by the Show Veterinarian at check-in before entering any livestock areas. All goats must be free of parasites, abscesses, ulcerations, ringworm, not under any quarantine, and not recently exposed to any infectious or contagious disease. Any animal deemed unfit by the Show Veterinarian or the Superintendent must be immediately removed from the fairgrounds by the exhibitor.

Awards

First: Ribbon, Second: Ribbon, Third: Ribbon

Showmanship Awards

Senior Showmanship:	Award
Reserve Senior Showmanship:	Award
Junior Showmanship:	Award
Reserve Junior Showmanship:	Award
Novice Junior Showmanship:	Award

Junior Dairy and Pet & Pack Showmanship Classes

Class	Description
100	Senior Dairy & Pet & Pack Goat Showmanship
101	Junior Dairy & Pet & Pack Goat Showmanship
102	Novice Dairy & Pet & Pack Goat Showmanship

Junior Dairy Goats Rules

- There will be no pre-show milk out. Dairy Goats are required to be milked out the evening prior to the show.
- Junior Dairy Goats may not be entered in market.
- Junior Dairy Goats are not required to be registered with the American Dairy Goat Association (ADGA) or any other dairy goat association.
- Goats must be entered in individual classes to be eligible for group classes.
- Senior doe entries must be in milk.
- Dairy and pet & pack goat showmanship classes will be shown together.
- Goats must be dehorned.

Junior Dairy Goat Awards

Best of Show: Award

Individual Junior Dairy Classes

Class	Description
103	Junior Kid, March 2023 through June 2023
104	Senior Kid, November 2022 through February 2023
105	Junior Yearling, May 2022 through October 2022
106	Senior Yearling, September 2020 through April 2022

Group Junior Dairy Classes

Class	Description
107	Junior Get-of-Sire, 3 does never freshened, list name of sire and names of all does

Individual Senior Dairy Classes

Class	Description
108	Yearling Milker, one year and under two
109	Two years and under three
110	Three years and under five
111	Five years and older

Group Senior Dairy Classes

Class	Description
112	Senior Get-of-Sire, 3 does in milk, list name of sire and names of all does
113	Produce of Dam, 2 daughters from the same dam, dame to be named
114	Breeders Choice, 3 does any age, all must be bred and owned by exhibitor

Junior Pet & Pack Goat**Rules**

- No bucks may be shown in this division, but wethers may be shown. Market goats may not be shown in this division.
- All goats in this division must be manageable in the show ring.
- Pet and Pack goats are not allowed to enter in the Market or Dairy goat classes, but can be entered in either or both Pack and Pet goat classes.
- Pack goats must be at an appropriate weight and height for carrying a pack. Pack goats will be shown with their packs on.
- Goats must be dehorned
- Age Requirements:
 - Pet Goats must be 6 months or older
 - Pack Goats must be 1 year or older by first day of fair

Awards

Pet Goat – Best of Show:	Award
Pack Goat – Best of Show:	Award
Pet & Pack Goat Grand Champion:	Award
Pet & Pack Goat Reserve Grand Champion:	Award

Classes

Class	Description
115	Pet Goat – Junior members (4-H)
116	Pet Goat – Senior members (4-H)
117	Pack Goat – Junior members (4-H)
118	Pack Goat – Senior members (4-H)

Junior Market Goat**Rules**

- Market goats are only eligible for Market and Showmanship classes.
- Female and male market goats are allowed to enter. Male goats must be wethered. All market goats must be dehorned, and ear tagged before June 15 or they will be disqualified.
- Market goats must be 1 year of age or younger by the first day of the Fair. No goats over the age of one year will be allowed.
- Goats will be weighed at the Fair and may be divided into equitable weight classes.
- Bracing of animals will be tolerated if the animal has all four (4) feet on the ground. Exhibitors may lift the feet off the ground for 10 seconds when posing the goat. Any violation will result in dismissal.

Showmanship Awards

Senior Showmanship:	Award
Reserve Senior Showmanship:	Award
Junior Showmanship:	Award
Reserve Junior Showmanship:	Award
Novice Junior Showmanship:	Award

Junior Market and Breeding Goat Showmanship Classes

Class	Description
119	Senior Market and Breeding Goat Showmanship
120	Junior Market and Breeding Goat Showmanship
121	Novice Market and Breeding Goat Showmanship (first year in project, juniors or seniors)

Junior Market Goat Awards

Grand Champion Market Goat:	Award
Reserve Grand Champion Market Goat:	Award

Classes

Class	Description
122	Market Goats

Junior Breeding Boer Goat**Rules**

- All goats must have ear tags or tattoo(s).
- Goats showing any pronounced defect or abnormality will be barred from showing.
- Bracing of animals will be tolerated if the animals has all four (4) feet on the ground. Exhibitors may lift the feet off the ground for 10 seconds when posing the goat. Any violation will result in dismissal
- Goats must be dehorned

Junior Breeding Goat Awards

Grand Champion Breeding Goat:	Award
Reserve Champion Breeding Goat:	Award
First: Ribbon, Second: Ribbon, Third: Ribbon	

Junior Breeding Goat Classes

Class	Description
123	Junior Doe Kid, March 2022 - June 2023
124	Senior Doe Kid, Nov. 2022 - February 2023
125	Junior Doe Yearling, May 2022 - Oct. 2022
126	Senior Doe Yearling, Sept. 2020 - April 2022
127	Yearling Doe, Two years and under three
128	Doe, Three years and under five
129	Aged Doe, Five years and older

Many Thanks To Our 2022 Sponsors!

Olsons Grain
Lori Willman



Junior Horse Show & Gymkhana

Department Code "JH"

Lori Penrod, Superintendent
(928) 699-0000

Entry Fee: \$0.00 / entry

Entry Forms Due: July 7

Western Show: Saturday, August 26, 8 a.m.

(Western Rain Date: Saturday, September 9)

English Show: Sunday, August 27, 8 a.m.

(English Rain Date: Sunday, September 10)

The English show may be held on Saturday August 26 in the afternoon if there are a small amount of participants. If the English show is moved to Saturday August 26 participants will be notified about a week in advance via email.

Gymkhana Show: Saturday, August 26, following the Western show.

All fair horse shows may occur on Saturday August 26 if the amount of entries allows.

All the horse shows will be held in the Posse Arena located north of the stables.

Note: The horse show dates are the weekend PRIOR to the Coconino County Fair.

Department Rules

1. All General Fair Rules and current Arizona State Fair 4-H Horse Show Rules apply.
2. Competitors may not cross enter between divisions. Those entered in Walk/Trot may not enter a Lope/Canter class.
3. 4-H exhibitors may enter open classes. Open classes will not qualify for the Arizona 4-H State Horse Show
4. 4-H Exhibitors are required to enter online at CoconinoCountyFair.com
5. Stalls are available on a first come, first serve basis. Horse Show participants receive complimentary stall rental on Friday, Saturday, and Sunday of the Horse Show. Shavings, camping, and stall cleaning fees will be charged at the prevailing rates. Stable Rules of Use are available on-site.
6. Reining patterns will be chosen from the current State 4-H Horse Show Rule Book. All jumping and trail patterns will be posted
7. 4-H Junior and Senior Western and English Showmanship winners are eligible to participate in Round Robin Showmanship when Round Robin takes place. See Round Robin section for more information.
8. Roping classes and goat tying will not be held at this show. If interested in qualifying for the Arizona State Fair 4-H Horse Show/Roping, contact Josh Farella by

June 1, 2023.

9. Competitors wishing to qualify for State Fair 4-H Horse Show must be currently enrolled in a Coconino County 4-H Horse Project and must compete in the appropriate Senior or Junior division. Novice and Open divisions are not eligible to compete in the Arizona State Fair. **Exhibitors wishing to qualify for the State Fair in the Jumping Classes must qualify in the appropriate class in order to be eligible. (i.e. 2' for Juniors, 2'6" for Seniors) State qualifying classes will be marked with an asterisk (*).**
10. **-NEW-** Approved Riding Helmets are mandatory for all divisions (ASTM F1163 equestrian).

Division Codes: (Must be used for all classes)

(J) - Junior 4-H, Age 8-13

(S) - Senior 4-H, Age 14-19

4H Novice Walk/Trot must enter the Open Novice or Walk/Trot

Awards

First through Sixth place ribbons will be awarded for each class. If there are more than 6 exhibitors, participation ribbons will be awarded to those exhibitors

Western Horse Show

Class	Description
100	Western Showmanship*
101	Western Pleasure*
102	Western Equitation*
103	Bareback Equitation*
104	Western Riding (Only J,S)*
105	Reining (Only J,S)*
106	Trail*
107	Ranch Riding*

English Horse Show

Class	Description
200	English Showmanship*
201	English Pleasure*
202	English Equitation (flat)*
203	English Bareback*
204	Hunter Hack
205	Hunt Seat Equitation over Fences
206	Working Hunter over Fences (Only J,S)

High Point Awards

Classes that will be used to calculate English High Point Awards will be: Showmanship, Pleasure, Equitation (flat), Bareback, Hunter Hack, Hunt Seat Equitation over Fences, and Working Hunter. Points will be awarded based on the number of exhibitors in each class

Classes that will be used to calculate Western High Point Awards will be: Showmanship, Pleasure, Equitation, Bareback, Trail, Western Riding, Reining and Ranch Riding.

All complaints will be handled by a grievance committee. Grievances must be filed before the end of each day's show and be accompanied with a \$40 grievance fee.

Awards

Grand Champion: Belt Buckle and Ribbon
 Reserve Champion: Belt Buckle and Ribbon
 First thru Sixth place: Ribbons

Gymkhana

Class Description
 300 Barrels (Only J,S)
 301 Poles (Only J,S)

Team Grooming Competition

Class Description
 400 Junior Horse Grooming Team

Team Grooming Competition Criteria

Team Members

Cleanliness and neatness of team members will be judged.

Safety

1. Required adult or older youth handler; horse is not tied to the fence
2. Gentle Horse and well trained
3. Never stand in Danger Zones directly in front of or behind horse
4. Team members must wear boots
5. Never knee or sit. Squat down so you can move quickly
6. When crossing behind a horse, either cross out of the range of hind legs or pass with a hand on horse

Teamwork

1. Be pleasant to fellow team members
2. Space out to work
3. Members will share the grooming of the horse equally

Trimming

1. Trim ears, bridle path, whiskers, jaw line and if possible fetlocks
2. Cut the bridle path only 1" long or as long as previously trimmed
3. Manes and tails cannot be trimmed more than 1/2 of an inch
4. Do not cut hair of lashes around the eyes

Supplies

1. Halter & lead rope Show halter is Optional (No chains)
2. Brushes
3. Tail and mane comb
4. Blunt scissors
5. Hoof pick, hoof polish and/or sandpaper
6. Grooming cloth/rags
7. One gallon bucket for water

Supplies Not Allowed

1. Commercial cleaning or grooming products
2. Razor Blades
3. Electrical equipment

Presentation

The horse and team members will be judged by:

1. The overall presentation of a groomed horse
2. Horse is groomed for a specific discipline (Western-English)
3. Questions answered correctly

Showmanship

1. Correctly performing the pattern
2. Correct quartering during inspection

Awards

First: Ribbon, Second: Ribbon

Many Thanks To Our 2022 Sponsors



Junior Poultry

Department Code "JP"



Anthony Campbell, Superintendent
(928) 614-8064, karabbitry@hotmail.com

Entry Fee: \$0.00 / entry

Entry Forms Due: August 4

Receiving Date: August 30, 3 - 7 p.m. &

August 31, 9 a.m. - 12 p.m.

Poultry Showmanship and Conformation:

September 1, 1 p.m.

WEIGHT LIMITS: The maximum weight for Chicken Fryers is 6 pounds, the minimum weight is 3 1/2 pounds. Turkey maximum is unlimited and minimum is 18 pounds.

Department Rules

1. General Livestock Rules and 4-H Livestock Rules apply.

2. All poultry will be checked upon receiving. Birds showing signs of disease or parasites will not be accepted. No exceptions!
3. Cages and feed will be provided by the Fair.
4. Exhibitors are required to show poultry in a showmanship class.
5. Poultry used in showmanship must be the exhibitor's own animal.
6. Market poultry must be designated and entered only in market poultry classes.
7. There will be no geese or ducks allowed as market poultry.
8. Barn duty sign-up sheet will be displayed near the barn office. Please sign-up for at least one two-hour time period. Junior exhibitors are required to do barn duty.
9. **Important Entry Information:**
 - a. The Junior Poultry Department code is "JP".
 - b. Determine the class or breed from listings following the Junior Poultry Awards.
 - c. See last page of poultry.

DEFINITIONS:

Cock - Male poultry hatched before January 1, 2023.

Hen - Female poultry hatched before January 1, 2023.

Cockerel - Male poultry hatched after January 1, 2023.

Pullet - Female poultry hatched after January 1, 2023.

Trio - 1 male and 2 female of any age; must be of the same breed and variety. A bird used in a trio may not be entered as a single.

Single - 1 bird in a class. A bird entered as a single may not be used in a trio.

Chicken Fryer Pen - 3 birds not over 12 weeks old, weighing between 3 1/2 and 6 pounds each. If any Fryer is over or under weight, the whole pen is eliminated. Uniformity in weight, size, appearance, condition and meat type must be present.

Market Turkey - must be under 8 months old. 18 lbs. minimum

Awards

First: Ribbon, Second: Ribbon, Third: Ribbon

Junior Herdsman Award

Plaque to be presented at Junior Fair Awards Program

Junior Poultry Showmanship Awards

Senior Poultry Showmanship:	Award
Reserve Senior Poultry Showmanship:	Award
Junior Poultry Showmanship:	Award
Reserve Junior Poultry Showmanship:	Award
Novice Poultry Showmanship:	Award
Reserve Novice Poultry Showmanship:	Award

Showmanship

Class	Description
100	Senior Poultry Showmanship
101	Junior Poultry Showmanship
102	Novice Poultry Showmanship (first year only, Junior and Senior)

Junior Market Poultry Awards

Grand Champion Fryer Pen of 3:	Award
Reserve Grand Champion Fryer Pen of 3:	Award
Grand Champion Market Turkey:	Award
Reserve Grand Champion Market Turkey:	Award

Market

Enter a single animal, either in a conformation or a market class; do not enter a single animal in both.

Class	Description
103	Chicken fryer pen (3 birds)
104	Market Turkey

Junior Poultry Awards

Grand Champion Poultry:	Award
Reserve Grand Champion Poultry:	Award
Champion Bantam:	Award
Reserve Bantam:	Award
Champion Standard:	Award
Reserve Standard:	Award
Champion (non-market) Turkey:	Award
Reserve Champion (non-market) Turkey:	Award
Champion Water Fowl:	Award
Reserve Champion Water Fowl:	Award
Champion Guinea:	Award
Reserve Champion Guinea:	Award
Champion Pigeon & Dove:	Award
Reserve Champion Pigeon & Dove:	Award
Champion Game Bird:	Award
Reserve Champion Game Bird:	Award

Champion Peafowl:	Award
Reserve Champion Peafowl:	Award
Champion Trio (non-market):	Award
Reserve Champion Trio (non-market):	Award

Special Awards

Champion Trio: Award
Best Poultry Picture: Award

Standard Chicken

Class	Description
105	Cock
106	Cockerel
107	Hen
108	Pullet
109	Trio
110	Egg pen, 3 laying hens, one breed
111	Hen with chicks, one breed

Bantam Chicken

Class	Description
112	Cock
113	Hen
114	Cockerel
115	Pullet
116	Trio
117	Egg pen, 3 laying hens, one breed
118	Hen with chicks, one breed

Turkey

Class	Description
119	Old Tom
120	Young Tom
121	Old Hen
122	Young Hen

Guinea

Class	Description
123	Young Cock
124	Young Hen
125	Old Cock
126	Old Hen

Pigeon And Dove

Class	Description
127	Pigeon Old Cock
128	Pigeon Young Cock
129	Pigeon Old Hen
130	Pigeon Young Hen
131	Dove Old Cock
132	Dove Young Cock
133	Dove Old Hen
134	Dove Young Hen

Duck

Class	Description
135	Old Drake
136	Young Drake
137	Old Duck
138	Young Duck

Geese

Class	Description
139	Old Gander
140	Young Gander
141	Old Goose
142	Young Goose

Game Bird

Class	Description
143	Old Cock
144	Young Cock
145	Old Hen
146	Young Hen
147	Pair

Peafowl

Class	Description
148	Old Cock
149	Young Cock
150	Old Hen
151	Young Hen
152	Pair

Poultry Picture

Pictures must be 5" x 7" or larger and must be of birds raised this year.

Class	Description
153	Any picture of poultry raised in 2023

Poultry

(Use the following breeds for both junior and open poultry)

Chicken

Breed and Description
Ameraucana, with full tail, any other
Ameraucana, with full tail, black
Ameraucana, with full tail, blue
Ameraucana, with full tail, blue wheaton
Ameraucana, with full tail, buff
Ameraucana, with full tail, splash
Ameraucana, with full tail, wheaton
Ameraucana, with full tail, white
Andalusian, blue
Antwerp Belgian, black
Antwerp Belgian, Mille Fleur
Antwerp Belgian, mottled
Antwerp Belgian, porcelain
Antwerp Belgian, quail
Antwerp Belgian, self blue
Antwerp Belgian, white
Araucana, Rumpless
Australorp
Booted Bantams, black
Booted Bantams, golden neck
Booted Bantams, Mille Fleur
Booted Bantams, porcelain
Booted Bantams, white
Brahma, buff
Brahma, dark
Brahma, light
Buckeye
Buttercup
Campine, gold
Campine, silver
Catalana, buff

Chantecler, partridge	Game, Old English, golden duckwing
Chantecler, white	Game, Old English, lemon blue
Cochin, barred	Game, Old English, self blue
Cochin, birchen	Game, Old English, silver duckwing
Cochin, black	Game, Old English, spangled
Cochin, blue	Game, Old English, white
Cochin, brown	Hamburg, black
Cochin, buff	Hamburg, golden penciled
Cochin, Columbia	Hamburg, golden spangled
Cochin, golden-laced	Hamburg, silver penciled
Cochin, mottled	Hamburg, silver spangled
Cochin, partridge	Hamburg, white
Cochin, red	Holland, barred
Cochin, silver-laced	Holland, white
Cochin, splash	Houdan, mottled
Cochin, white	Houdan, white
Cornish Cross, Meat	Japanese, black
Cornish, Black	Japanese, black-tailed, buff
Cornish, Blue Laced Red	Japanese, black-tailed, white
Cornish, buff	Japanese, gray
Cornish, dark	Japanese, mottled
Cornish, Mottled	Japanese, white
Cornish, Spangled	Java, black
Cornish, white	Java, mottled
Cornish, white-laced red	Jersey Giant, black
Crevecoeur	Jersey Giant, white
Cubalaya, black	Jungle Fowl
Cubalaya, black-breasted red	Ko Shamo
Cubalaya, white	La Fleche
D'uccles, black	Lakenvelder
D'uccles, brown red	Lamonas
D'uccles, golden Neck	Langshan, black
D'uccles, Mille DeFleur	Langshan, white
D'uccles, porcelain	Leghorn, black
D'uccles, self blue	Leghorn, black-tailed red
D'uccles, white	Leghorn, buff
Delaware	Leghorn, dark brown
Dominique	Leghorn, golden duckwing
Dorking, colored	Leghorn, light brown
Dorking, silver gray	Leghorn, red Columbian
Dorking, white	Leghorn, silver
Egyptian Faymouis	Leghorn, white
Faverolle, salmon	Malay, black
Faverolle, white	Malay, red pyle
Frizzle, black	Malay, spangled
Frizzle, blue	Malay, wheaton
Frizzle, buff	Malay, white
Frizzle, red	Maran, Black Copper
Frizzle, white	Maran, Cuckoo
Game, modern, blue red	Maran, wheaton
Game, modern, birchen	Minorcas, black
Game, modern, black	Minorcas, buff
Game, modern, black-breasted red	Minorcas, white
Game, modern, brown red	Naked Neck, black
Game, modern, golden duckwing	Naked Neck, blue
Game, modern, lemon blue	Naked Neck, buff
Game, modern, red pyle	Naked Neck, red
Game, modern, silver duckwing	Naked Neck, white
Game, modern, wheaten	New Hampshire
Game, modern, white	Orloff, Spangled
Game, Old English, black-breasted red	Orpington, black
Game, Old English, blue-breasted red	Orpington, blue
Game, Old English, crete	Orpington, buff
Game, Old English, cuckoo	Orpington, white
Game, Old English, ginger red	Phoenix, golden

Phoenix, silver
 Plymouth Rock, barred
 Plymouth Rock, blue
 Plymouth Rock, buff
 Plymouth Rock, Columbian
 Plymouth Rock, partridge
 Plymouth Rock, silver-penciled
 Plymouth Rock, white
 Polish, bearded, buff
 Polish, bearded, golden
 Polish, bearded, silver
 Polish, bearded, white
 Polish, black crested, white-bearded
 Polish, black-crested, white non-bearded
 Polish, non-beard, buff-laced
 Polish, non-beard, golden
 Polish, non-beard, silver
 Polish, non-beard, white
 Polish, non-beard, white-crested black
 Polish, non-beard, white-crested blue
 Redcap
 Rhode Island Red
 Rhode Island White
 Rosecomb, black
 Rosecomb, blue
 Rosecomb, blue wheaton
 Rosecomb, splash
 Rosecomb, white
 Sebright, buff
 Sebright, golden
 Sebright, silver
 Serama, white
 Serama, any other
 Shamo
 Shamo, bb red
 Shamo, black
 Shamo, wheaton
 Silkies, black
 Silkies, blue
 Silkies, buff
 Silkies, partridge
 Silkies, white
 Spanish, white-faced black
 Sultan
 Sumatra, black
 Sumatra, blue
 Sussex, light
 Sussex, red
 Sussex, speckled
 Wellsummer
 Wyandotte, black
 Wyandotte, blue
 Wyandotte, Blue-laced red
 Wyandotte, buff
 Wyandotte, Columbian
 Wyandotte, gold-laced
 Wyandotte, partridge
 Wyandotte, silver-laced
 Wyandotte, silver-penciled
 Wyandotte, white
 Yokohama, red shoulder
 Yokohama, white
 Any other

Turkey

Breed and Description
 Black Spanish
 Bourbon Red
 Broad Brested White
 Bronze
 Narragansett
 Royal Palm
 Slate
 White Holland
 Any Other

Guineas

Breed and Description
 Buff
 Bun dundotte
 Coral blue
 Lavender
 Pearl
 Purple
 Slate
 White
 Any Other

Pigeon & Dove

Birds hatched prior to 2023 are classed as “old cock” and “old hen”. Birds hatched during 2023 are classed as “young cock” or “young hen”. One entry per breed. Varieties will be judged separately.

Breed and Description
 Archangel
 Budapest
 Fantails
 Flight
 Homer
 Ice Pigeon, Clean leg
 Ice Pigeon, Muffed
 Modena
 Mookie
 Nun
 Parlor Roller
 Pheasant Pigeon
 Rock
 Roller
 Saxon Field
 Any Other Pigeon
 Diamond Dove
 Ringneck Dove
 White Dove
 Any Other Dove

Water Fowl Breeds

Duck

Breed and Description
 Australian Spotted
 Aylesbury
 Blue Swedish
 Buff
 Cayuga
 Crested
 Call, Blue
 Call, Butterscotch
 Call, Fawn-White

Call, Grey
 Call, White
 Call, Snowy
 Call, Pencilled
 East Indies, Black
 East Indies, Blue
 East Indies, Silver
 Khaki Campbell
 Magpie
 Mallard, Grey
 Mallard, Snowy
 Mandarin
 Muscovy, black
 Muscovy, blue
 Muscovy, chocolate
 Muscovy, white
 Pekin
 Rouen
 Runner
 Saxony
 Silver Appleyard
 Wood
 Any Other

Geese

Breed and Description
 African
 Buff
 Chinese
 Embden
 Pilgrim
 Saddleback Pomeranian
 Sebastopol, white
 Toulouse
 Tufted Roman
 Any Other

Partridge

Breed and Description
 Chukar
 Any Other

Quail

Breed and Description
 Bobwhite
 Button
 Cooturnix
 Gamble
 Texas Blue Scale
 Any Other

Pheasants

Breed and Description
 Buff
 Chinese Ringneck
 Lady Amhurst
 Melanistic Mutant
 Red Golden
 Reeves
 Silver
 White
 Yellow Golden
 Any Other

Peafowl

Breed and Description
 Black Shoulder
 Blue
 Pied
 White
 Any Other

Rule 9c. Please do 1 entry for showmanship. No breed required. Do separate entry for your bird under its class and breed.

Many Thanks To Our 2022 Sponsor!

Adonia Yachts

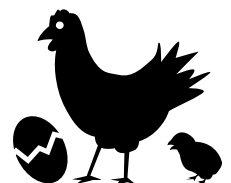

Junior Rabbits & Cavies

Department Code "JR"



Stacie Muller-Stotts, Superintendent
(928) 380-6078, sfm32@nau.edu

Entry Fee: \$0.00 / entry

Entry Forms Due: August 4

Receiving Date: August 30, 3 - 7 p.m. & August 31, 9 a.m. - 12 p.m.

Rabbits and Cavies Showmanship: September 1, 9 a.m.

WEIGHT LIMITS: The maximum weight for Meat Pens is 5 1/2 pounds, the minimum weight is 3 1/2 pounds.

Department Rules

- General Livestock Rules and 4-H Livestock Rules apply.**
- All exhibitors are required to show their specific species (rabbit, cavy or both) in their specified class for showmanship.
- All Junior 4-H exhibitors must sign up for barn duty for post-fair barn clean-up, unless barn is cleaned immediately following the close of the Fair on Monday. If needed, date will be determined by barn superintendent.
- Rabbits and Cavies entered in the Junior 4-H department will be judged by the standards set forth by the American Rabbit and Cavy Breeders' Association (ARBA).
- When filling out entry form, please add one entry simply for showmanship. Add a separate entry for the breed and variety of your animal. Therefore, if you are only doing showmanship, you would have one entry for showmanship in the appropriate class and one entry for your animal for a total of 2 entries on the entry form.
- All exhibitors are required to show their own animals.
- All animals must have identification. For rabbits, a tattoo or sharpie identification in the left ear of the rabbit. For cavies, an ear ring with identifying information.
- All rabbits and cavies brought to the judging table should be properly groomed. Grooming facilities will be available in rabbit building. Bring your own grooming supplies.
- Wool entries for Angora Rabbits – see Club Work department.

- Sale signs may go up starting Sunday at 9 a.m.
- NO animal is allowed to leave the barn without the JR. Rabbit Superintendent's approval.
- All 4-H members are responsible for cleaning up their own pens for their rabbits before checking rabbits out on Monday. This rule holds true for every rabbit entered in the barn belonging to that exhibitor.
- All rabbit and cavy sales and exchanges MUST take place OUTSIDE of the barn, only after the exhibitor has completed the check out process and checked out the animals that they checked in.
- All market animals must be entered as market only.
- All Doe and litter must be entered only as Doe and litter and not by specific breed.
- Doe and litter – The litter must be at least 6 weeks old to be entered in the barn and no more than 12 weeks old to qualify for Doe and Litter.

Market Rabbit Rules

- All exhibitors must show in showmanship in order to have a meat pen entered in the 4-H JR. Rabbit Department.
- All 4-H exhibitors must be registered with NAJLA (Northern Arizona Junior Livestock Association) by the appropriate deadline.
- All 4-H exhibitors must adhere to the NAJLA and Junior Livestock rules listed in the Fair Book and must have signed the agreements provided by NAJLA.
- Meat pens are to consist of three rabbits, no more than 10 weeks old. Each rabbit must weigh between 3 1/2 & 5 1/2 pounds.
- All rabbits must be weighed in by the Weighing Committee. Official weights are recorded and given to the Junior Rabbit Superintendent. If any one of the three rabbits in the pen are overweight or underweight, the entire meat pen will be eliminated.
- The three qualities, in the order of their importance, for judging meat pens are as follows:
 - Meat type
 - Condition
 - Uniformity which consists of: weight, size, appearance, condition and meat type, as prescribed in the ARBA Standard of Perfection book.
- All meat pens will be weighed in upon arrival. Check with Superintendent as to when and where that will occur.
- Meat pens must have been entirely raised by exhibitor.

Awards

First, Second, and Third: Ribbon

Junior 4-H Herdsman Award

Plaque to be presented at Junior Fair Awards Program

Junior Rabbit Showmanship Awards

Senior Rabbit Showmanship:	Award
Reserve Senior Rabbit Showmanship:	Award
Junior Rabbit Showmanship:	Award
Reserve Junior Rabbit Showmanship:	Award
Novice Rabbit Showmanship:	Award

Class

Class	Description
100	Senior Rabbit Showmanship
101	Junior Rabbit Showmanship
102	Novice Rabbit Showmanship (first year in project, Juniors or Seniors)

Junior Market Rabbits**Awards**

Champion Rabbit Meat Pen:	Award
Reserve Champion Rabbit Meat Pen:	Award

Class	Description
103	Pen of Three Market Rabbits

Junior Rabbits**Awards**

Best in Show:	Award
Best of Breed:	Award
Best Doe and Litter (over 3 in class):	Award

Rabbits

Class	Description
104	Senior Buck
105	Senior Doe
106	Junior Buck
107	Junior Doe
108	Doe and litter, at least 6 weeks old
109	Intermediate Buck
110	Intermediate Doe
111	Pre Junior Buck
112	Pre Junior Doe

Junior Cavy Showmanship Awards

Senior Cavy Showmanship:	Award
Reserve Senior Cavy Showmanship:	Award
Junior Cavy Showmanship:	Award
Reserve Junior Cavy Showmanship:	Award
Novice Cavy Showmanship:	Award

Class	Description
113	Senior Cavy Showmanship
114	Junior Cavy Showmanship
115	Novice Cavy Showmanship (first year in project, Juniors or Seniors)

Junior Cavies Awards

Best of Show:	Award
Best of Breed (over 3 in class):	Award

Cavy

Class	Description
116	Senior Boar, over 32 oz
117	Senior Sow, Over 32 oz
118	Intermediate Boar, 22-32oz
119	Intermediate Sow, 22-32 oz
120	Junior Boar, 12-21 oz
121	Junior Sow, 12-21oz
122	Sow and Litter 3-4 weeks
123	Pet Cavy
124	Mixed Breed

Junior Cavy

Breed and Description
Abyssinian
Abyssinian Satin
Abyssinian Tan
American
American Satin
Coronet
Handicap
Peruvian
Peruvian Satin
Pet Cavy
Silkie
Silkie Satin
Sow With Litter
Teddy
Teddy Satin
Texel
White Crested

Junior and Open Rabbit Breeds

Breed and Description
American Fuzzy Lop, Broken
American Fuzzy Lop, Solid
American Sable
American, Blue
American, Chinchilla
American, White
Argente Brun
Belgian Hare
Beveren, Black
Beveren, Blue
Beveren, White
Blanc de Hotot
Britannia Petite, BEW
Britannia Petite, Black
Britannia Petite, Black Otter
Britannia Petite, Broken
Britannia Petite, Chestnut Agouti
Britannia Petite, Ruby Eyed White
Britannia Petite, Sable Marten
Californian
Champagne D'Argent
Checkered Giant, Black
Checkered Giant, Blue
Cinnamon
Crème D'Argent
Dutch, Black
Dutch, Blue
Dutch, Chinchilla
Dutch, Chocolate
Dutch, Gray
Dutch, Steel
Dutch, Tortoise
Dwarf Papillon, Chocolate
English Angora, Colored
English Angora, White
English Lop, Broken
English Lop, Solid
English Spot, Black
English Spot, Blue
English Spot, Chocolate
English Spot, Gold
English Spot, Gray

English Spot, Lilac	Mini Satin, Chocolate
English Spot, Tortoise	Mini Satin, Chocolate Agouti
Flemish Giant, Black	Mini Satin, Copper
Flemish Giant, Blue	Mini Satin, Himalyan
Flemish Giant, Fawn	Mini Satin, Opal
Flemish Giant, Light Gray	Mini Satin, Otter
Flemish Giant, Sandy	Mini Satin, Red
Flemish Giant, Steel Gray	Mini Satin, Siamese
Flemish Giant, White	Mini Satin, Silver Marten
Florida White	Mini Satin, Squirrel
French Angora, Colored	Mini Satin, Tortoise
French Angora, White	Mini Satin, White
French Lop, Broken	Netherland Dwarf, Agouti
French Lop, Solid	Netherland Dwarf, AOV
Giant Angora	Netherland Dwarf, Self
Giant Chinchilla	Netherland Dwarf, Shaded
Harlequin, Japanese	Netherland Dwarf, Tan Pattern
Harlequin, Magpie	New Zealand, Black
Havana, Black	New Zealand, Broken
Havana, Blue	New Zealand, Red
Havana, Broken	New Zealand, White
Havana, Chocolate	Open Pet Rabbit
Himalayan, Black	Palomino, Golden
Himalayan, Blue	Palomino, Lynx
Himalayan, Chocolate	Polish, Black
Himalayan, Lilac	Polish, Blue
Holland Lop, Broken	Polish, Blue Eyed White
Holland Lop, Solid	Polish, Broken
Hotot	Polish, Chocolate
Jersey Wooly, Agouti	Polish, Ruby Eyed White
Jersey Wooly, AOV	Rex, Amber
Jersey Wooly, Broken Self	Rex, Black
Jersey Wooly, Shaded	Rex, Blue
Jersey Wooly, Tan Pattern	Rex, Broken
Lilac	Rex, Californian
Lionhead, Black	Rex, Castor
Lionhead, Chocolate	Rex, Chinchilla
Lionhead, REW	Rex, Chocolate
Lionhead, Seal	Rex, Lilac
Lionhead, Siamese Sable	Rex, Lynx
Lionhead, Tort	Rex, Opal
Mini Lop, Broken	Rex, Otter
Mini Lop, Solid	Rex, Red
Mini Rex, Bew	Rex, Sable
Mini Rex, Black	Rex, Seal
Mini Rex, Blue	Rex, White
Mini Rex, Broken	Rhineland
Mini Rex, Castor	Satin, Angora White or Colored
Mini Rex, Chinchilla	Satin, Black
Mini Rex, Chocolate	Satin, Blue
Mini Rex, Himalayan	Satin, Broken
Mini Rex, Lilac	Satin, Californian
Mini Rex, Lynx	Satin, Chinchilla
Mini Rex, Opal	Satin, Chocolate
Mini Rex, Otter	Satin, Copper
Mini Rex, Red	Satin, Otter
Mini Rex, Seal	Satin, Red
Mini Rex, Silver Marten	Satin, Siamese
Mini Rex, Smoke Pearl	Satin, White
Mini Rex, Tortoise	Silver Fox
Mini Rex, White	Silver Fox, Black
Mini Satin, Black	Silver Marten, Black
Mini Satin, Blue	Silver Marten, Blue
Mini Satin, Broken	Silver Marten, Chocolate
Mini Satin, Chinchilla	Silver Marten, Sable

Silver, Black
Silver, Brown
Silver, Fawn
Standard Chinchilla
Tan, Black
Tan, Blue
Tan, Chocolate
Tan, Lilac
Thrianta
Youth Pet Rabbit

Many Thanks To Our 2022 Sponsors!



Junior Sheep

Department Code "JS"



Bailee Cameron, Superintendent
(928) 699-8363, baileecameron@icloud.com

Entry Fee: \$0.00 / entry

Entry Forms Due: July 7

Receiving Date: August 31, 9 a.m. - 4 p.m.

Market & Breeding Sheep Conformation:

September 1, 6:30 p.m.

Lamb Showmanship: September 1, 6:30 p.m.

Breeding Sheep Show: September 1, 7:30 p.m.

WEIGHT LIMITS: The maximum weight for Market Sheep is unlimited, the minimum weight is 90 pounds.

2024 FAIR WEIGHT LIMITS: The minimum weight will be increasing to 100 pounds.

Department Rules

- 1. General Livestock Rules and 4-H Livestock Rules apply.**
- All ownership deadlines will be observed. All market sheep must be owned by the 4-H member. Breeding sheep may be co-owned or leased, but must be under the daily care of the 4-H member for the required time. Sheep may be shown by only one exhibitor and those animals must be under the daily care of only one 4-H member.
- Neutered animals may not be shown in breeding classes.
- Sheep that are not entered in the Fair will not be allowed on the fairgrounds without prior approval from CCPR as an exhibition.
- All sheep must be inspected by the Show Veterinarian at the fair before entering any livestock areas.
- In-State Sheep: Livestock Inspection Papers (hauling papers) must accompany all in-state sheep exhibits and must be turned in to the Superintendent or Livestock inspector. All sheep must be checked by the Show Veterinarian at the fair before entering any livestock areas. All sheep must not be infected with Bluetongue, nor exposed to scrapie, nor originate from a scrapie infected source or flock.
- All sheep must be free of parasites, abscesses or ulcerations, and ringworm; not under any quarantine; and not recently exposed to any infectious or contagious disease. Any animal deemed unfit by the veterinarian must be immediately removed from the fairgrounds by the exhibitor.
- Sheep will not be accepted if their tails have been

surgically removed. If prolapse occurs during the Fair, a veterinarian will be called at the sheep owner's expense. Veterinarian recommendations will be followed.

- Each 4-H Club is expected to have representatives in the Sheep Barn to meet the public and share educational information about Sheep. There will be a sign-up sheet available for this Barn Duty beginning at 7 p.m. Thursday evening. Exhibitors will sign up several times for Barn Duty depending on how many members are exhibiting. More than one member will be on duty at a time. Educational exhibits are encouraged; please make arrangements ahead of time with the Superintendent.
- Exhibitors will maintain their pen and surrounding area for a public and educational setting. Aisles must be kept neat and clean at all times.
- Animal pens must be cleaned and animals must be fed no later than 8:30 a.m. every morning.
- Sheep must be shown with all four feet on the ground.
- Muzzles may be used on an animal only if the exhibitor creates an educational poster about the purpose and proper use of muzzles. The poster must be displayed in the animal's pen.
- Flock and Pair exhibits: Animals entered and shown in Flock and Pair Classes must be owned by and under the daily care of the exhibitor. Each animal must be entered as an individual, and only one Flock or Pair entry is allowed.
- Lambs must be slick shorn prior to receiving at the fair. Trimming may be done at the fair but only by the exhibitor.
- Mats and/or carpets will be allowed ONLY if they can be secured and kept in place.
- The Superintendent reserves the right to combine limited entry classes.
- Base date for ages of livestock can be found in the General Livestock Rules.

Market & Breeding Sheep Rules

- All Market and Breeding Lambs will be exhibited slick shorn.
- A Veterinarian will have the option to mouth and sift any obviously over-aged lambs. All eight lamb teeth must be in place.
- After weigh-in, market and breeding lambs will be divided into equitable weight classes for judging.

Junior Lamb Showmanship

Awards

Senior Market Lamb Showmanship:	Award
Reserve Senior Market Lamb Showmanship:	Award
Junior Market Lamb Showmanship:	Award
Reserve Junior Market Lamb Showmanship:	Award
Novice Market Lamb Showmanship:	Award
Herdsmen:	Award

Class

Showmanship classes do not require a breed description on the entry form.

Class Description

- 100 Senior Market Lamb Showmanship
- 101 Junior Market Lamb Showmanship
- 102 Novice Market Lamb Showmanship
- 103 Pee Wee Lamb Showmanship

Junior Market Lamb**Awards**

- | | |
|-------------------------------------|-------|
| Grand Champion Market Lamb: | Award |
| Reserve Grand Champion Market Lamb: | Award |

Class

Class Description

- 105 Market Lamb

Junior Breeding Sheep**Awards**

- | | |
|-----------------------|-------|
| Grand Champion Ram: | Award |
| Reserve Champion Ram: | Award |
| Grand Champion Ewe: | Award |
| Reserve Champion Ewe: | Award |

Ram

Class Description

- 106 Ram, over 1 year, under 2 years
- 107 Fall Ram Lamb, Sept. 2022 to Jan. 2023
- 108 Spring Ram Lamb, after Jan. 1, 2023

Ewe

Class Description

- 109 Ewe, over 1 year, under 2 years
- 110 Fall Ewe Lamb, Sept. 2023 to Jan. 2023
- 111 Spring Ewe Lamb, after Jan. 1, 2023

Group

Class Description

- 112 Pair of Ewe Lambs
- 113 Best Pair, either sex and age, both owned by exhibitor



**Many Thanks To Our
2022 Sponsors!**



Junior Swine

Department Code "JM"



Sandy Engelke, Superintendent
(928) 380-8143, wje47@msn.com

Entry Fee: \$0.00 / entry

Entry Forms Due: July 7

Receiving: August 31, 9 a.m. - 4 p.m.

Market Swine Conformation: September 1, 10 a.m.

Swine Showmanship: September 1, 10 a.m.

Hog Bowl: September 3, Following Round Robin

WEIGHT LIMITS: The maximum weight for Market Swine is 325 pounds, the minimum weight is 225 pounds.

Department Rules

1. General Livestock Rules and 4-H Livestock Rules apply.
2. Junior Market swine exhibitors must have a current Youth Livestock Quality Assurance Certificate.
3. Swine Classification Procedures:
 - a. Market swine will be divided into classes by breed. There must be at least four entries to create a breed class. Please see Breed Classification Standards at the end of this section. Superintendent will combined classes as needed.
 - b. Exhibitors will identify the breed of their swine in the description column on the on-line form.
 - c. This is a Market Show. Breed Classification will be confirmed at time of weigh-in by superintendent and/or Classifier. Classification of swine is final.
 - d. At receiving, all swine must be clean and groomed so that all breed characteristics are visible. The Superintendent and Breed Classifier have the right to request an animal be washed before it is classified.
4. Swine must not be scaly, have excessively dry skin, sunburned, or any unsightly condition. Swine not show ring groomed and clean will be sifted. Feet must be trimmed if needed.
5. No feed is to be stored in barn area or in empty pens unless approved by the Superintendent.
6. Pens must be cleaned each day of the Fair by 9:30 a.m. Wood shavings or pellets should be kept reasonably dry and free of manure throughout the Fair.
7. All feeding should be completed by 9:30 a.m. and feed pans removed from pens by 9:30 a.m.
8. Watering should be monitored throughout the day. Automatic watering devices are allowed, but not mandatory. Automatic waterers that leak must be removed

from pen.

9. Due to space limitations, each exhibitor is only allowed to enter one swine in this Department.
10. Water is the only compound that may be applied to hogs. Oil and paint are not allowed and if used, will be grounds for disqualification.
11. Hogs must be bedded on shavings/pellets only. Exhibitors must supply all bedding for their hog(s).
12. Exhibitors should write their name on all feed and equipment; bags, buckets, feeders, etc.
13. Exhibitors must drive their hog to the show ring without using a crate walker. Crate walkers are only to be used to load your hog into the scale during weigh-in or to the wash rack, no exceptions. Training your hog to drive is an essential part of your hog project and should be done prior to the Fair.
14. **Exhibitors are expected to be in the holding pen with their hog prior to the start of their respective class. Shows will not be held for an exhibitor or their hog. It is the sole responsibility of the exhibitor to be in the holding pen with their hog on time; parental assistance is encouraged.**
15. **Coaching an exhibitor during the market or showmanship show is not allowed. You will be asked to leave the show if observed coaching an exhibitor.**
16. Awards won in the Swine Barn may be displayed above your individual pen. Only awards given by the Swine Barn will be displayed.

Showmanship Class

Showmanship classes do not require a breed name on the entry form.

Class Description

- | | |
|-----|---|
| 100 | Junior Swine Showmanship |
| 101 | Senior Swine Showmanship |
| 102 | Novice Swine Showmanship (first year only, Junior and Senior) |

Market Class

Class Description

- | | |
|-----|--------------|
| 103 | Market Swine |
|-----|--------------|

Breed Names

Breed and Description

- | |
|-------------------------|
| All Other Breeds, Dark |
| All Other Breeds, Light |
| Berkshire |
| Chester White |
| Crossbred |
| Duroc |
| Hampshire |
| Hereford |
| Landrace |
| Poland China |
| Spotted Swine |
| Tamworth |
| Yorkshire |



Breed Classification Standards

Berkshire

1. Black and white with erect ears exhibiting Berkshire character.
2. A Berkshire must have white on all four legs, face and tail (unless tail is docked). One of the white leg points may also be missing.
3. Must be ear notched within seven days of birth.
4. A Berkshire must NOT have a solid white or a solid black face from ears forward.
5. A Berkshire must NOT have a solid black nose (rim of nose).
6. White is allowed on the ears, but NO solid white may appear on the ears.
7. Occasional splash of white may appear on the body.

Chester White

1. Must possess Chester White Breed characteristics.
2. Must be ear notched within seven days of birth.
3. Must be solid white in color, no color on the skin larger than a silver dollar, no colored hair.
4. Any skin pigmentation other than white that exceeds five in number is disqualified.
5. Ears must be down and medium size.
6. Any signs of weighted ear tags or evidence of past existence of such ear tags is not permissible and is grounds for disqualification.

Duroc

1. Must be red in color and possess Duroc Breed character, ears must be down and medium in size.
2. Must be ear notched within seven days of birth.
3. Must NOT have any white hair located on the animal.
4. Must NOT have any black hair.
5. Must NOT have more than three black spots on the skin and none of these spots can be larger than two inches in diameter.
6. Must NOT have any shading or indication of a belt.

Hampshire

1. Must be black in color with a white belt starting on the front leg. The belt may partially or totally encircle the body.
2. Must possess Hampshire Breed character, meaning ears must be erect and not rounded.
3. Must be ear notched within seven days of birth.
4. Must NOT have any white hair or indications of streaking on the forehead.
5. Must NOT have any red hair.

Hereford

1. The ideal color markings shall be red, light, or dark, however, deep red is preferred with a white head, ears, and at least 2 white feet.
2. At least 50% white face, at least 50% red body.
3. Ears must be at least broke forward and medium size.
4. Must be ear notched within seven days of birth.

Landrace

1. Must be white in color and possess Landrace Breed character, meaning ears must be down.
2. Must be ear notched within seven days of birth.
3. Must NOT have any color hair other than white.
4. Must NOT have more than three spots of skin pigmentation.
5. Must NOT have any spot of skin pigmentation larger than one U.S. minted quarter.

Poland China

1. Must possess Poland China Breed characteristics.
2. Must be ear notched within seven days of birth.
3. Must be black with six white points (face, feet and switch) with an occasional splash of white on the body. A hog may not possess more than one solid black leg and be determined as Poland China.
4. Must have ears down.
5. Must not have evidence of a belt formation.
6. Cannot have red or sandy hair and/or pigmentation.
7. Hogs that have weighted ear tags or evidence of tampering of ears with possible ear tags are ineligible.

Note: Tail docking is permissible.

Spotted Swine

1. Must be black and white.
2. Must possess Spotted Breed characteristics.
3. Must be ear notched within seven days of birth.
4. Ears cannot be erect.
5. Any red tinted or brown spots are ineligible.
6. No solid black head from ears forward.
7. No distinct white belt pattern (hair or skin) encircling and extending down and onto each shoulder.
8. Any signs of weighted ear tags or evidence of passed existence of such tags are determined ineligible and are grounds for disqualification.

Tamworth

1. Must be red in color (no more than 5% black hair) and possess Tamworth Breed Character.
2. Must be ear notched within seven days of birth.
3. Except for hooves, no white should appear on the body.
4. Dark spots with general appearance of pinpricks or speckling on the skin ONLY are typical of the breed.
5. Must not show if ears extend less than 65 degrees from the head.
6. Ears should be pointed, uprights, and give the appearance of alertness.

Yorkshire

1. Must be white in color and possess Yorkshire Breed characteristics, meaning ears must be erect.
2. Must be ear notched within seven days of birth.
3. Must NOT have any colored hair other than white.
4. Must NOT have colored skin pigmentation larger than one U.S. minted silver dollar.
5. Must NOT have masking above the eyes larger than a U.S. minted silver dollar.

Awards

2023 Market Awards

Grand Champion Hog: Buckle

**Sponsored by Lake Powell Furniture
Kip and Melissa Bennett
Babbitt Wholesale**

Blanket

Reserve Grand Champion Hog: Buckle

Ironside Electric

Breed Champions: Rosettes

**Sponsored by Adonia Yachts -
St. George, Utah
4-H Leader's Council**

Banners

2023 Showmanship Awards

Champion Senior Showman: Buckle

**Sponsored by
Green Mountain Construction**

Reserve Senior Showman: Buckle

Provided by the Coconino County Fair

Champion Junior Showman: Buckle

Sponsored by the Engelke Family

Reserve Junior Showman: Buckle

Provided by the Coconino County Fair

Champion and Reserve Novice Showman: Buckle

Provided by the Coconino County Fair

Champion Showmanship: Rosettes

**Sponsored by Adonia Yachts -
St. George, Utah**

Swine Herdsman: Award

Sponsored by Joe & Sandy Engelke



2022 Hog Bowl:

**Official HOG Bowl T-Shirt Sponsor
Mike Loven**

Raffle Sponsor

Copper Canyon Trading - Williams, AZ

Champion HOG Bowl Winner

Mr. Mike Brackin



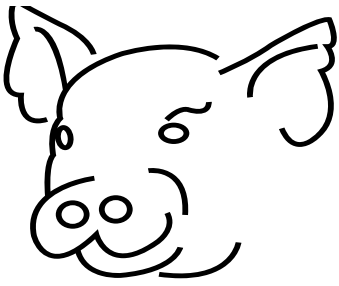

2022 HOG BOWL

Thank You Sponsors!



BIG JOHN'S TEXAS BARBEQUE

Preparer of Fine Texas-Style Smoked Brisket

LOVEN CONTRACTING



Kevin & Laura Kelley

Open Horse Show

Department Code "OH"

Lori Penrod, Superintendent
(928) 699-0000

Entry Fee: \$5.00 / entry

Entry Forms Due: July 21

Western Show: Saturday, August 26, 8 a.m.

(Western Rain Date: Saturday, September 9)

English Show: Sunday, August 27, 8 a.m.

The English show may be held on Saturday August 26 in the afternoon if there are a small amount of participants. If the English show is moved to Saturday August 26 participants will be notified about a week in advance via email.

(English Rain Date: Sunday, September 10)

All fair horse shows may occur on Saturday August 26 if the amount of entries allows.

All the horse shows will be held in the Posse Arena located north of the stables.

Note: The horse show dates are the weekend PRIOR to the Coconino County Fair.

Department Rules

1. All General Fair Rules and general AQHA rules apply (see aqha.com).
2. All non-4-H Exhibitors must complete the Open Horse Entry Form. An entry fee of \$5/class must accompany an entry.
3. Stalls are available on a first come, first serve basis. Horse Show participants receive complimentary stall rental on Friday, Saturday, and Sunday of the Horse Show. Shavings, camping, and stall cleaning fees will be charged at the prevailing rates. Stable Rules of Use are available on-site.
4. Entrants in Persons with disabilities classes may be accompanied by walkers and leaders.
5. Entrants from out of County will be accepted in the Open Classes only (\$5 entry fee applies.)
6. Open classes will be divided into junior exhibitor (18 and under) and adult exhibitor if number entries so warrant.
7. Approved Riding Helmets are mandatory for all participants 18 years of age and under at time of show.

Division Codes (Must be used for all classes.)

(N) - Novice Rider or Horse

(O) - Open Adult

(PD) - Persons with disabilities, all ages

(WT) - Walk/Trot

Western Horse Show

Class	Description
100	Western Showmanship
101	Western Pleasure
102	Western Equitation
103	Bareback Equitation

104 Western Riding (no walk/trot)

105 Reining (no walk/trot)

106 Trail

107 Ranch Riding

English Horse Show

Class Description

200 English Showmanship

201 English Pleasure

202 English Equitation (flat)

203 English Bareback

204 Hunter Hack

205 Crossrails Over Fences

206 Hunt Seat Equitation over Fences

207 Working Hunter over Fences

High Point Awards

Classes that will be used to calculate English High Point Awards will be: Showmanship, Pleasure, Equitation (flat), and Bareback. Hunter Hack, Hunt Seat Equitation over Fences, and Working Hunter will be awarded a High Point. Classes that will be used to calculate Western High Point Awards will be: Showmanship, Pleasure, Equitation, Bareback, Trail, Western Riding, Reining and Ranch Riding. Points will be awarded based on the number of exhibitors in each class.



Sponsored by
**Friends of Coconino
County Parks**

Awards

Grand Champion	Ribbon
Reserve Champion	Ribbon
First thru Sixth place	Ribbons
Western Open Champion:	\$40
Western Open Reserve Champion:	\$30
Western Novice Open Walk/Trot:	\$20
English Open Champion:	\$40
English Open Reserve Champion:	\$30
English Novice Open Walk/Trot:	\$20
English Open Jumping:	\$20

Many Thanks To Our 2022

Sponsor!

Friends of Coconino County Parks

Thank you 2022 Volunteers!

Ashley	Penrod
Eric	Treece
Greg	Penrod
Josh	Farella



Open Poultry

Department Code "OP"



Connie Lipinski, Superintendent
(928) 637-3766

Entry Fee: \$1.00 / entry

Entry Forms Due: August 18

**Receiving Date: August 30 3 - 7 p.m. &
August 31 9 a.m. - 12 p.m.**

Judging Date: August 31 & September 1, 1 p.m.

Department Rules

1. All General Fair Rules, Livestock Rules, Open Livestock Rules, and the National Show Ring Code of Ethics for Coconino County apply.
2. This Department is open to out-of-county residents, however, preference is given to Coconino County residents.
3. Only one entry per class for each breed.
4. The Fair will provide coops, feeding and cleaning. All eggs become property of the Coconino County Fair and vitality will be destroyed.
5. Judging will be by comparison, in accordance with the American Poultry Association Standard of Perfection and the American Bantam Standard.
6. The terms "cock" and "hen" are defined as birds hatched prior to January 1, 2023. The terms "cockerel" and "pullet" are birds hatched after January 1, 2023. A trio consists of one male and two females of any age, but the same breed and variety.
7. All poultry will be checked at receiving. Specimens showing evidence of disease or infested with vermin will not be accepted. All birds should be deloused one week prior to the show.
8. Birds entered as singles cannot compete as exhibition trios, nor can birds entered as exhibition trios compete as single entries.
9. Important Entry Information:
To enter an animal in Open Poultry:
 - a. The Open Poultry Department code is "OP".
 - b. Use the breed name listing in the Junior Poultry Department to determine the correct breed.
 - c. Use the class number listings following the Open Poultry Awards Section.**

Awards

First: Ribbon, Second: Ribbon, Third: Ribbon
Grand Champion Trio: \$20
Grand Champion Land Fowl: \$20

Grand Champion Water Fowl: \$20
Champion Turkey: \$10
Reserve Champion Turkey: \$5
Champion Guinea: \$10
Reserve Champion Guinea: \$5
Champion Duck: \$10
Reserve Champion Duck: \$5
Champion Goose: \$10
Reserve Champion Goose: \$5
Champion Game Bird: \$10
Reserve Champion Game Bird: \$5
Champion Pigeon or Dove: \$10
Reserve Champion Pigeon or Dove: \$5
Champion Standard Bird: \$10
Reserve Champion Standard Bird: \$5
Champion Standard Trio: \$10
Champion Bantam Bird: \$10
Reserve Champion Bantam Bird: \$5
Champion Bantam Trio: \$10



Sponsored by
**Friends of Coconino
County Parks**

Standard Chicken

Class	Description
100	Cock
101	Cockerel
102	Hen
103	Pullet
104	Trio
105	Egg pen, 3 laying hens, one breed
106	Hen with chicks, one breed

Bantam Chicken

Class	Description
107	Cock
108	Hen
109	Cockerel
110	Pullet
111	Trio
112	Egg pen, 3 laying hens, one breed
113	Hen with chicks, one breed

Turkey

Class	Description
114	Old Tom
115	Young Tom
116	Old Hen
117	Young Hen

Guinea

Class	Description
118	Old Cock
119	Young Cock
120	Old Hen
121	Young Hen

Pigeon And Dove

Class	Description
122	Pigeon Old Cock
123	Pigeon Young Cock
124	Pigeon Old Hen
125	Pigeon Young Hen
126	Dove Old Cock
127	Dove Young Cock
128	Dove Old Hen
129	Dove Young Hen

Game Bird

Class	Description
130	Old Cock
131	Young Cock
132	Old Hen
133	Young Hen

Peafowl

Class	Description
134	Old Cock
135	Young Cock
136	Old Hen
137	Young Hen

Open Water Fowl**Duck**

Class	Description
138	Old Drake
139	Young Drake
140	Old Duck
141	Young Duck

Geese

Class	Description
142	Old Gander
143	Young Gander
144	Old Goose
145	Young Goose

**Many Thanks To Our 2022****Sponsors!**

Friends of Coconino County Parks
Anthony Campbell
Olsen's Grain

Thank you 2022 Volunteers!

Brandon Stevens	Danielle Stevens
Lisa Adams	Robert Kennedy
Ryan Adams	Ted Lyons
Teresa Konkol	

Open Rabbits & Cavies

Department Code "OR"

Doreen Holtje, Superintendent
dholtje@gmail.com

Entry Fee: \$1.00 / entry**Entry Forms Due: August 11****Receiving Date: August 30, 3 – 7 p.m.****Judging Date: August 31, 9 a.m.**

Entrants need not be members of the American Rabbit Breeders Association (ARBA) to enter rabbits or cavies. Anyone owning an animal of an ARBA-recognized breed may enter that animal in the ARBA-sanctioned show, provided it has an identifying ear tattoo. Mixed breed as well as purebred rabbits and cavies are accepted for entry into the non-ARBA pet class, and do not need ear tattoos.

Department Rules

1. All General Fair Rules, Livestock Rules, Open Livestock Rules, and the National Show Ring Code of Ethics for Coconino County will apply.
2. All breeds and varieties recognized by ARBA will accepted for entry. Those under a working standard will also be accepted and judged, provided the entrant gives a copy of the official Working Standard to the Superintendent prior to judging. However, animals under a working standard may not qualify for all awards.
3. The Coconino County Fair is a member of the American Rabbit Breeders Association. This show will be governed and run by the current official rules of ARBA. The judge's decisions will be final.
4. This is an Official ARBA Sanctioned Show. The ARBA Executive Director is Eric Stewart, P.O. Box 400, Knox, PA 16232, www.arba.net. Membership Dues: Individual: \$20 per year, \$50 for 3 years. Husband/Wife: \$30 per year, \$75 for 3 years. Youth \$12 per year, \$30 for 3 years. The ARBA National Convention will be held Oct. 21st to Oct. 25th 2023 at the Kentucky Expo Center
5. Entries will be limited according to space available. This department is open to both in-county and out-of-county residents. Preference will be given to Coconino

County residents. Exhibitors will be notified if any of their entries are not accepted.

6. All rabbits entered in ARBA Sanctioned Show must have a permanent tattoo mark in the left ear. Cavies may be marked with a metal tag.
7. Exhibitors may enter more than one (1) animal in any one class.
8. Absolutely no animals will be released from their cages without permission of the Superintendent. Nothing is to be placed on or in cages without permission of Superintendent.
9. The Coconino County Fair will provide pens, feeding, and general care of the exhibitors' animals. All exhibitors are requested to volunteer at least one morning or evening of barn duty during the run of the fair. A sign up sheet will be available at check-in.
10. The Department Superintendent will be in charge of stock entered for exhibition. Coconino County employees and volunteers will in no case be responsible for any loss or damage which may occur, and entries are made with this accepted condition.
11. The Fair is not responsible for animals left after specified release times.
12. Youth (under the age of 18) may enter in both the open and youth show with different animals, but the same animal cannot be entered in both shows.
13. For Sale signs will be no larger than a 8.5"x11" sheet of paper and may not be posted until Sunday after 10 a.m. You may also enter a dollar amount on the entry tag.
14. If an exhibitor sells an animal during the run of the Fair, that animal will be released by the Superintendent at the specified release time to the registered exhibitor only. The exhibitor must conduct the transaction and exchange of the animal outside of the barn building.

Breed Entries: Please list sex, breed, and variety under description. Classes will be provided for all ARBA recognized breeds and those under an ARBA working standard.

Meat Pens: Pen of three (3) fryers, 3-5 lbs. Each, of the same breed and variety, up to 10 weeks old. Underweight or overweight rabbits within the pen will cause the whole pen to be disqualified. All meat pens will be weighed just prior to judging under the supervision of the judge.

Doe and Litter: Each doe and litter entry shall consist of one (1) doe and no more than eight (8) kits. Kits will be no younger than five (5) weeks and no older than eight (8) weeks of age.

Breed Fur: All rabbits entered in fur classes must be entered in general competition.

Open Rabbits Awards

- Open Rabbit Best in Show: \$25
- Open Rabbit Youth Best in Show: \$25
- Open Cavy Best in Show: \$25
- Open Cavy Youth Best in Show: \$25
- Best Pet Rabbit: \$25
- Best Pet Cavy: \$25
- Best Doe and Litter: \$25
- Best Meat Pen: \$25



Sponsored by
**Friends of Coconino
County Parks**

Open Rabbit Ribbon Awards

Best in Show:	Award
Best of Breed:	Award
Best Opposite Sex of Breed:	Award
Best of Variety:	Award
Best Opposite Sex of Variety:	Award
Best Doe and Litter:	Award
Best Meat Pen:	Award

Pet Rabbits Awards

This section is open to all ages, and is judged by grooming, handling, and personality.

Best Pet:	Award
Reserve Best Pet:	Award

Open Rabbits

Class	Description
100	Open Senior Buck
101	Open Senior Doe
102	Open Intermediate Buck
103	Open Intermediate Doe
104	Open Junior Buck
105	Open Junior Doe
106	Open Pre-Junior Buck
107	Open Pre-junior Doe
108	Open Doe and Litter
109	Open Meat Pen
110	Open Pen of Three
200	Open Youth Senior Buck
201	Open Youth Senior Doe
202	Open Youth Intermediate Buck
203	Open Youth Intermediate Doe
204	Open Youth Junior Buck
205	Open Youth Junior Doe
206	Open Youth Pre-Junior Buck
207	Open Youth Pre-junior Doe
208	Open Youth Doe and Litter
209	Open Youth Meat Pen
210	Open Pen of Three
300	Pet Rabbit

Open Rabbit Breeds

Breed and Description

American Fuzzy Lop, Broken
 American Fuzzy Lop, Solid
 American Sable
 American, Blue
 American, Chinchilla
 American, White
 Argente Brun
 Belgian Hare
 Beveren, Black
 Beveren, Blue
 Beveren, White
 Blanc de Hotot
 Britannia Petite, BEW
 Britannia Petite, Black
 Britannia Petite, Black Otter
 Britannia Petite, Broken
 Britannia Petite, Chestnut Agouti
 Britannia Petite, Ruby Eyed White
 Britannia Petite, Sable Marten
 Californian
 Champagne D'Argent
 Checkered Giant, Black
 Checkered Giant, Blue
 Cinnamon
 Crème D'Argent
 Dutch, Black
 Dutch, Blue
 Dutch, Chinchilla
 Dutch, Chocolate
 Dutch, Gray
 Dutch, Steel
 Dutch, Tortoise
 Dwarf Papillon, Chocolate
 English Angora, Colored
 English Angora, White
 English Lop, Broken
 English Lop, Solid
 English Spot, Black
 English Spot, Blue
 English Spot, Chocolate
 English Spot, Gold
 English Spot, Gray
 English Spot, Lilac
 English Spot, Tortoise
 Flemish Giant, Black
 Flemish Giant, Blue
 Flemish Giant, Fawn
 Flemish Giant, Light Gray
 Flemish Giant, Sandy
 Flemish Giant, Steel Gray
 Flemish Giant, White
 Florida White
 French Angora, Colored
 French Angora, White
 French Lop, Broken
 French Lop, Solid
 Giant Angora
 Giant Chinchilla
 Harlequin, Japanese
 Harlequin, Magpie
 Havana, Black
 Havana, Blue
 Havana, Broken
 Havana, Chocolate
 Himalayan, Black
 Himalayan, Blue
 Himalayan, Chocolate
 Himalayan, Lilac
 Holland Lop, Broken
 Holland Lop, Solid
 Hotot
 Jersey Woolly, Agouti
 Jersey Woolly, AOV
 Jersey Woolly, Broken Self
 Jersey Woolly, Shaded
 Jersey Woolly, Tan Pattern
 Lilac
 Lionhead, Black
 Lionhead, Chocolate
 Lionhead, REW
 Lionhead, Seal
 Lionhead, Siamese Sable
 Lionhead, Tort
 Mini Lop, Broken
 Mini Lop, Solid
 Mini Rex, Bew
 Mini Rex, Black
 Mini Rex, Blue
 Mini Rex, Broken
 Mini Rex, Castor
 Mini Rex, Chinchilla
 Mini Rex, Chocolate
 Mini Rex, Himalayan
 Mini Rex, Lilac
 Mini Rex, Lynx
 Mini Rex, Opal
 Mini Rex, Otter
 Mini Rex, Red
 Mini Rex, Seal
 Mini Rex, Silver Marten
 Mini Rex, Smoke Pearl
 Mini Rex, Tortoise
 Mini Rex, White
 Mini Satin, Black
 Mini Satin, Blue
 Mini Satin, Broken
 Mini Satin, Chinchilla
 Mini Satin, Chocolate
 Mini Satin, Chocolate Agouti
 Mini Satin, Copper
 Mini Satin, Himalayan
 Mini Satin, Opal
 Mini Satin, Otter
 Mini Satin, Red
 Mini Satin, Siamese
 Mini Satin, Silver Marten
 Mini Satin, Squirrel
 Mini Satin, Tortoise
 Mini Satin, White
 Netherland Dwarf, Agouti
 Netherland Dwarf, AOV
 Netherland Dwarf, Self
 Netherland Dwarf, Shaded
 Netherland Dwarf, Tan Pattern
 New Zealand, Black
 New Zealand, Broken
 New Zealand, Red
 New Zealand, White

Open Pet Rabbit
 Palomino, Golden
 Palomino, Lynx
 Polish, Black
 Polish, Blue
 Polish, Blue Eyed White
 Polish, Broken
 Polish, Chocolate
 Polish, Ruby Eyed White
 Rex, Amber
 Rex, Black
 Rex, Blue
 Rex, Broken
 Rex, Californian
 Rex, Castor
 Rex, Chinchilla
 Rex, Chocolate
 Rex, Lilac
 Rex, Lynx
 Rex, Opal
 Rex, Otter
 Rex, Red
 Rex, Sable
 Rex, Seal
 Rex, White
 Rhinelander
 Satin, Angora White or Colored
 Satin, Black
 Satin, Blue
 Satin, Broken
 Satin, Californian
 Satin, Chinchilla
 Satin, Chocolate
 Satin, Copper
 Satin, Otter
 Satin, Red
 Satin, Siamese
 Satin, White
 Silver Fox
 Silver Fox, Black
 Silver Marten, Black
 Silver Marten, Blue
 Silver Marten, Chocolate
 Silver Marten, Sable
 Silver, Black
 Silver, Brown
 Silver, Fawn
 Standard Chinchilla
 Tan, Black
 Tan, Blue
 Tan, Chocolate
 Tan, Lilac
 Thrianta
 Youth Pet Rabbit

Open Cavy Ribbon Awards

Best in Show Open	Award
Reserve in Show Open	Award
Best in Show Open Youth	Award
Reserve in Show Open Youth	Award

Open Cavy Class

Use the following classes for all Open Adult Cavy breeds. Exhibitors age 18 and older, exhibitors 17 and younger should use Open Youth Class Codes.

Class	Description
400	Open Senior Boar, over 32 oz
401	Open Senior Sow, over 32 oz
402	Open Intermediate Boar, 22-32oz
403	Open Intermediate Sow, 22-32 oz
404	Open Junior Boar, 12-21 oz
405	Open Junior Sow, 12-21oz
406	Open Sow and Litter 3-4- weeks
500	Open Youth Senior Boar
501	Open Youth Senior Sow
502	Open Youth Intermediate Boar Boar
503	Open Youth Intermediate Boar Senior Boar
504	Open Youth Junior Boar
505	Open Youth Junior Sow
506	Open Youth Sow and Litter
600	Pet Cavy

Open Cavy Breeds

Breed and Description
 Abyssinian
 Abyssinian Satin
 Abyssinian Tan
 American
 American Satin
 Coronet
 Handicap
 Peruvian
 Peruvian Satin
 Pet Cavy
 Silkie
 Silkie Satin
 Sow with Litter
 Teddy
 Teddy Satin
 Texel
 White Crested

Many Thanks to Our 2022 Sponsors and Volunteers!

Friends of Coconino County Parks
 Realtor, Paula Mack
 Flagstaff Housekeeping
 LaBri Independent Consultant, Stacy Muller



93.9
THE MOUNTAIN

92.9
KRAFF
country

ARIZONA
Hope
103.9 PRESCOTT 107.9 FLAGSTAFF

MAGIC
99.1

THE MOUNTAIN
2.0

KRAFF
news

THE LEGEND
93-5 AM 930

HITS
106
ALL THE HITS

Proud Partner of the Coconino County Fair

Great  Media
ONLINE ON SITE

Open Youth

Department Code "OY"



Beverly Standing, Superintendent (928) 699-2185



Becca Dickerson, Superintendent (928) 699-5567

Entry Fee: \$0.00 / entry

Entry Form Due: August 11

Receiving: August 29, 3 - 7 p.m.

Releasing entries after: September 4, 4 p.m.

Department Rules

1. All General Fair Rules apply.
2. The Danish System for judging will be used. The Danish System judges each item on its own merits, not against other items.
3. Entry Rules:
 - a. There is a limit of five entries per exhibitor within this Department. One 1-day admission to the Fair per exhibitor with five entries.
 - b. This Department is open to Coconino County residents under 18 years of age as of July 31, 2023. Exhibitors age 16 and 17 may enter as an adult in Home Economics.
 - c. Only articles completed within the last year are eligible and must be the work of the exhibitor.
 - d. Only 1 entry per class per exhibitor will be accepted.
 - e. Food entries within the same class from several members of the same family must obviously be from different batches and totally the work of the individual exhibitor.
 - f. All items must be clean and in good repair. Encourage children to enter their BEST work.
4. No item may be removed from the building before 4 p.m. on Monday, the last day of the Fair. You will not be permitted to enter the fairgrounds free of charge before 4 p.m. on Monday to pick up your exhibits. The building will remain open until 6 p.m. that day for pick up of exhibits.

Division Code

(Y) Youth

Awards

- First: Ribbon, Second: Ribbon, Third: Ribbon
- People's Choice: \$50
- Best of Photography: \$25
- Best of Artwork: \$25
- Best of Crafts: \$25
- Best of Baked Goods: \$25
- Best of Decorated Cake: \$25
- Best of Cookies: \$25



Sponsored by
**Friends of Coconino
County Parks**

- Best of Sewing: Gift certificate
- Best Quilted Item: Gift Certificate
- Best Recycled Art: Gift Certificate
- Best Item from Persons with Disabilities: Gift Certificate

Sewing

All items entered must have a hanger, dowel or other means of hanging in order to display.

Class	Description
100	Appliquéd item
101	Apron
102	Baby blanket
103	Blanket
104	Blouse
105	Coat or jacket
106	Doll
107	Doll clothes
108	Dress
109	Dress, formal
110	Fashion accessory
111	Infant item
112	Pillow
113	Potholder
114	Quilted item
115	Shirt
116	Skirt
118	Sleepwear
120	Vest
121	Western wear
122	Any other sewing item



from
**Odegaard's
Sewing Center**



from
**Odegaard's
Sewing Center**

Crochet

Class	Description
123	Afghan
125	Doily
126	Infant item

127	Infant set
128	Jumbo crochet
130	Pillow cover
131	Poncho
132	Pot holders
133	Purse
134	Scarf
136	Slippers
137	Sweater
138	Toys
139	Vest
140	Any other crochet item

Knitting

Class	Description
141	Afghan
144	Doily
145	Doll clothing
146	Infant set, Infant item
147	Jumbo knitting
148	Mittens
149	Pillow cover
150	Pot holder
151	Purse
152	Shawl
153	Slippers
154	Sweater
155	Toys
156	Vest
157	Any other knitted item

Miscellaneous Needlework

Class	Description
158	Appliqué
159	Candlewicking
160	Counted cross stitch
161	Crewel
162	Cross stitch
163	Embroidery
164	Latch hook
165	Needle punch
166	Needlepoint
167	Smocking
168	Yarn canvas
169	Any other Misc Needlework item

Artwork

All artwork MUST be properly displayed on construction paper, poster board, or matboard. No glass or frames.

Class	Description
170	Chalk drawing
171	Charcoal drawing
172	Colored pencil drawing
173	Computer art
174	Crayon coloring, original work
175	Drawing, pen
176	Drawing, pencil
177	Etching
178	Finger painting
179	Marker drawing
180	Mixed media
181	Oil Pastels
182	Paint by number
183	Painting - oil or acrylic

184	Painting - watercolor
185	Photography - black & white
186	Photography - color
187	Sand painting
188	Sculpture
189	Tempera painting
190	Tissue paper
191	Any other Artwork

Recycled Art

Artwork created using only recycled materials.

Class	Description
192	Recycled Material Art

Crafts

Class	Description
193	4th of July
194	Batik
195	Beadwork
196	Candle
197	Ceramic
198	Christmas
199	Clay
200	Decorated hat
201	Decorated shoes
202	Doll
203	Dough
204	Easter
205	Egg crafts
206	Fall item
207	Fathers Day
208	Felt
209	Flowers
210	God's eye
211	Halloween
212	Jewelry
213	Kit (Paint Acrylic)
214	Kite
215	Leatherwork
216	Macaroni craft
217	Macrame
218	Magnet
219	Masks
220	Melted bead article
221	Miniature furniture
222	Mobile
223	Model (no Lego)
224	Mothers Day
225	Musical Instrument
226	Paper craft
227	Paper Mache'
228	Pipe Cleaners
229	Pom-Pom
230	Popsicle stick
231	Pot Holder
232	Puppet
233	Spring
234	St. Patrick's Day
235	Stained glass
236	String art
237	Stuffed toy
238	Summer
239	Textile paint
240	Thanksgiving
241	Tie-dye



- 242 Tole painting
- 243 Toothpick
- 244 T-shirt, any
- 245 Valentine's Day
- 246 Wall plaque
- 247 Weaving
- 248 Winter
- 249 Woodcraft—Kit
- 250 Woodcraft—No Kit
- 251 Wrought iron
- 252 Yarn craft
- 253 Any other craft item

Persons with Physical Disabilities

This category is for exhibitors with physical disabilities.

- | Class | Description |
|-------|-------------|
| 254 | Art, PC |
| 255 | Craft, PC |
| 256 | Food, PC |

Persons with Intellectual Disabilities

This category is for exhibitors with intellectual disabilities.

- | Class | Description |
|-------|-------------|
| 257 | Art, MC |
| 258 | Craft, MC |
| 259 | Food, MC |



Sponsored by
**C-A-L Ranch
Stores**

Food Preparation Rules

1. Exhibit foods on white 6" foam or paper plate, enclosed in a plastic zip lock bag.
2. Entries too large for paper plate may be exhibited on cardboard covered with aluminum foil, and exhibit covered with plastic wrap.
3. Follow specific requirements for quantities and/or sizes.

Baked Goods

Baked goods should be displayed as follows:

Bread - 1/3 loaf; Rolls, muffins, etc. - 3 per plate.

- | Class | Description |
|-------|---------------------------|
| 260 | Biscuits, Baking powder |
| 261 | Cinnamon rolls |
| 262 | Coffee Cake |
| 263 | Cornbread |
| 264 | Donuts, cake or raised |
| 265 | Muffins |
| 266 | Tortillas, corn |
| 267 | Tortillas, flour |
| 268 | Yeast bread, novelty |
| 269 | Yeast bread, white |
| 270 | Yeast bread, whole wheat |
| 271 | Yeast bread/rolls, fancy |
| 272 | Yeast rolls, plain shaped |
| 273 | Bread, gluten-free |
| 274 | Bread, any other |

Cakes

Except for decorated cakes, you may exhibit two 3" wedges for cakes and 3 each for cupcakes.

- | Class | Description |
|-------|---------------------------------|
| 275 | Chocolate cake, frosted |
| 276 | Chocolate cake, unfrosted |
| 277 | Cupcakes, frosted |
| 278 | Cupcakes, unfrosted |
| 279 | White or yellow cake, frosted |
| 280 | White or yellow cake, unfrosted |
| 281 | Decorated cake |
| 282 | Gluten-free cake |
| 283 | Any other cake |

Cookies

Plate of 3, give name of cookie.

- | Class | Description |
|-------|--------------------------------------|
| 284 | Bar cookies |
| 286 | Chocolate brownies |
| 287 | Chocolate chip cookies |
| 288 | Drop cookies |
| 289 | Filled, any other, cookies |
| 290 | Fruit cookies |
| 291 | International cookies |
| 292 | Macaroon cookies |
| 293 | Molasses cookies |
| 294 | Novelty cookies |
| 295 | Oatmeal cookies |
| 296 | Peanut butter cookies |
| 297 | Pumpkin, carrot, or zucchini cookies |
| 298 | Spritz cookies |
| 299 | Sugar cookies |
| 300 | Decorated cookies |
| 301 | Any Gluten-free cookies |
| 302 | Any other cookies |

Pies (no cream pies)

Exhibit 1/4 pie on foam or paper pie plate.

- | Class | Description |
|-------|-------------|
| 303 | Any pie |

Candy

Exhibit 5 candies on a paper plate.

- | Class | Description |
|-------|-----------------|
| 304 | Chocolate fudge |
| 305 | Divinity |
| 306 | Dipped |
| 307 | English toffee |
| 308 | Peanut brittle |
| 309 | Mints |
| 310 | Taffy |
| 311 | Sucker/lollipop |
| 312 | Any other candy |

Canning & Food Preparation

Write method of preparation on entry.

Class	Description
313	Canned fruit
314	Canned vegetables
315	Dried fruit, fruit leather
316	Dried meat, jerky
317	Jam
318	Jelly
319	Pickles
320	Preserves
321	Relish
322	Salsa
323	Specialty fruit
324	Any other canned or prepared food

Thank You 2022 Volunteers!

Anna Cancino
Ben Fillerup
Candace Smith
Cheynne Smith
Daniella Standing
Donald Barnes
Emily Guerrero
Heather Chavarria
Jillian Farrell
Karen Fillerup
Tami Suchowiejko

Enter the King Arthur Flour Contest to win additional prizes. See entry form in Home Economics.



Thank You 2022 Award Sponsors!

Friends of Coconino County Parks
Odegaard's Sewing Center
Eat n' Run
Cal Ranch



Schools

Department Code "SC"



Lynda Locke, Superintendent.
 (928) 527-3253, llocke@q.com
 (480) 223-2819

Entry Fee: \$0.00 / entry

Entry Form due: August 18
Receiving: August 27 from 12 - 3 p.m.
August 28 & August 29 from 3 - 6 p.m.
Releasing entries after: September 4 at 4 p.m.

Department Rules

1. All General Fair Rules apply.
2. **Please fill out Entry Form C or Enter Online.**
3. Open to all schools in Coconino County. A school's exhibit display must be submitted by school personnel. **All entries must be part of a school's exhibit display. Any club, team, classroom, or school program can enter a display in the Schools Building; a school should develop a display which showcases what they believe to be the best parts of their school. A school may submit more than one entry.**
4. **Each student made item should be labeled with student's first name and grade level. All school displays must fit within the provided area (see illustration below).** School personnel must provide all materials needed to assemble display.
5. All exhibits must be completed by 6 p.m. the **TUESDAY** before the 1st day of the Fair.
6. Exhibits cannot be changed or taken down before 4 p.m. on the last day of the Fair. All displays must be removed by school personnel between 4 p.m. to 6 p.m. on Monday, the last day of the Fair. All displays must be removed completely and the display area must be left as you found it.
7. Four schools with the best display will receive a \$50 award and a rosette. The display will not be judged on quality or quantity of items displayed but rather judged by the overall appearance of the school's display.
8. As long as space allows, all entries will be displayed. Entries found offensive in any way will not be exhibited. The Fair is a family event. The Department Superintendents will make the decision.



Sponsored by
**Friends of Coconino
 County Parks**

Special Thanks To Our 2022 Sponsor!

Friends of Coconino County Parks

Thanks You 2022 Volunteers!

Anna Whorton
 Cindi Chatters
 Cindy Johnson
 Deion Davis
 Fern Chatters
 Gail Griffith-Moore
 Kahnya Astin
 Leanna Tsosie
 Leonor Schlachter
 Tami Suchowiejko

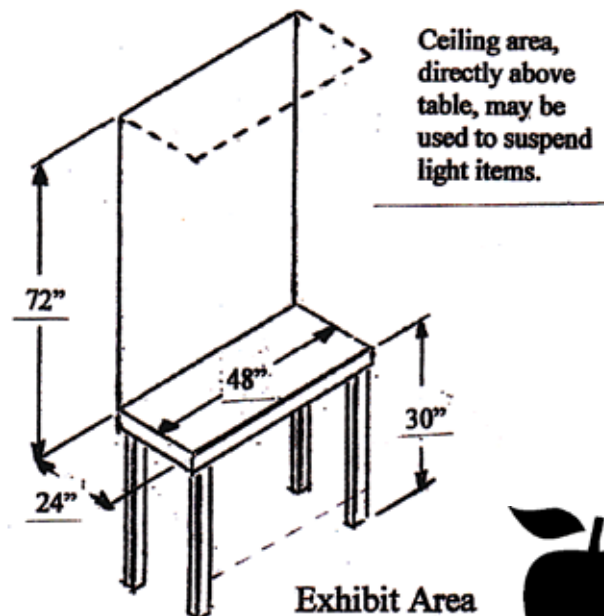



SCHOOLS DAY

Friday, September 1, 2023 10AM - 2PM

Students and their chaperones are invited to attend the Fair for FREE!!

All schools who would like to participate in Schools Day must pre-register. No walk-up registration will be accepted. To pre-register call 928-679-8000 or email fair@coconino.az.gov. Check-in starts at 9:30 a.m. and goes until 2:00 p.m. Schools are encouraged to wear identifying clothing or name badges.

Chaperone Guidelines for Free Entry

Pre-school – Kindergarten:	1 chaperone per 5 students
Grades 1 – 3:	1 chaperone per 5 students
Grades 4 and up:	1 chaperone per 8 students
Home school:	1 chaperone per 4 children

Coconino County Parks & Recreation presents the County Fair
Labor Day Weekend
September 1 – September 4

For more information,
 visit CoconinoCountyFair.com
 or call 928-679-8000.



The Coconino County Fair has music all day, every day! Check out **CoconinoCountyFair.com** for updates on our entertainment schedule, and don't forget to grab a program when you get to the Fair.



Saturday September 2nd
2:30-3:30

Sunday September 3rd
2:30-3:30

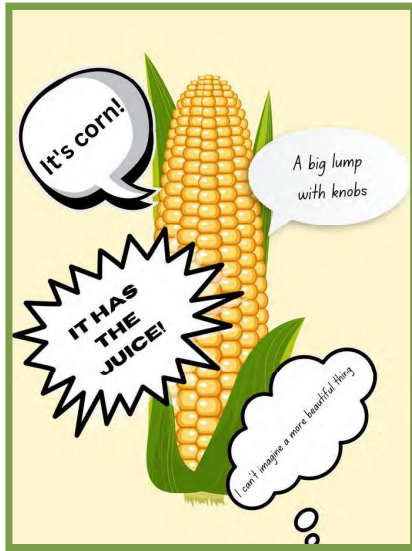

Main Stage Contests

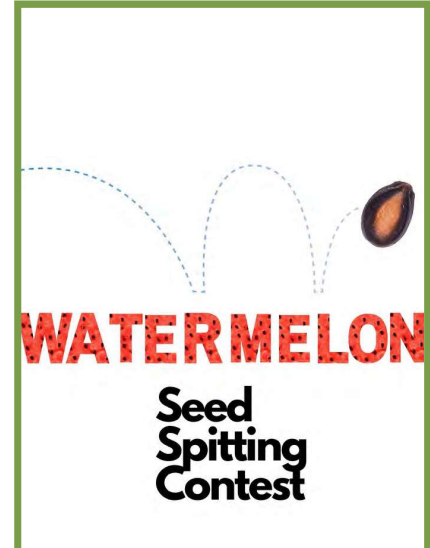

Prizes for Winners

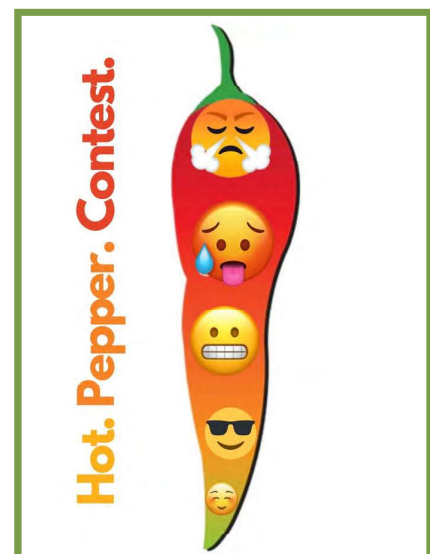

All Fairgoers Welcome

Feel the beat of summer



©2023 The Coca-Cola Company.

Coca-Cola

